



**10**year  
warranty

## Structure

**piètement:** façonné en aluminium moulé sous pression, peint avec des poudres époxydiques avec finition gaufrée. La partie supérieure est équipée d'un insert pour la fixation au châssis périmétrique. Le piètement est équipé d'un patin métallique réglable revêtu en polyéthylène qui permet un réglage de +10 mm pour la mise à niveau.

**châssis périmétrique:** composé de profils en aluminium extrudé peint avec des poudres époxydiques avec une finition gaufrée, équipé d'une rainure interne pour la fixation de l'insert du piètement. Les traverses de renfort sont fixées sur la profondeur de la structure. Les profils et les traverses ont aussi une rainure pour la fixation éventuelle d'accessoires.

## Plateau

**mélamine:** réalisé en aggloméré ép. 18 mm (densité 720 kg/m<sup>3</sup>, classe d'émission de formaldéhyde E1, conforme aux exigences CARB), recouvert de résines mélaminées antireflet et bordé en ABS (ép. 2 mm avec bords arrondis).

**Fenix:** composé d'un panneau d'aggloméré de 16 mm d'épaisseur (densité 720 kg/m<sup>3</sup>, émission de formaldéhyde E1, conforme aux exigences CARB), plaqué sur le côté supérieur avec Fenix NTM de 0,9 mm d'épaisseur, et sur le côté inférieur avec stratifié en haute pression (HPL) de 0,9 mm d'épaisseur. Le panneau est bordé d'ABS de 1 mm d'épaisseur avec bords arrondis. Le plateau a une épaisseur totale de 18 mm.

**verre peint:** 10 mm d'épaisseur, trempé conformément à la norme EN 12150, à bords plats et polis, peint à l'eau sur la face inférieure (si la peinture est blanche ou gris taupe, on utilise un verre extra-clair). Le plateau est équipé de goujons en acier avec des trous filetés collés sur la face inférieure.

**verre dépoli et peint:** 10 mm d'épaisseur, trempé conformément à la norme EN 12150, à bords plats et polis, dépoli en côté supérieure et peint à l'eau en côté inférieure (si la peinture est blanche ou taupe, on utilise un verre extra-clair). Le plateau est équipé de goujons en acier avec des trous filetés collés sur côté inférieure.

## Voile de fond

**mélamine:** réalisé en aggloméré ép. 18 mm (densité 720 kg/m<sup>3</sup>, classe d'émission de formaldéhyde E1, conforme aux exigences CARB), recouvert de résines mélaminées antireflet et bordé en ABS (ép. 2 mm avec bords arrondis) et soutenu par deux supports en acier peints avec des poudres époxy avec finition gaufrée et fixés latéralement aux traverses de renfort les plus extérieures. Le voile de fond est disponible en deux hauteurs: 30 cm e 56 cm.

# Segrino

## Struttura

Structure

Structure



### AL - Alluminio - Aluminium - Aluminium

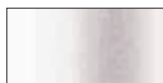

**ZGBI - Verniciato gofrato bianco**  
White embossed painted  
Verni gaufré blanc  
**RAL 9010**



**ZGTR - Verniciato gofrato tortora**  
Dove embossed painted  
Verni gaufré gris taupe



**ZGNE - Verniciato gofrato nero**  
Black embossed painted  
Verni gaufré noir  
**RAL 9005**

## Piano

Top

Plateau

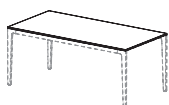

sp./th. 18 mm

### M - Melaminico - Melamine - Mélamine

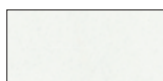

**MBI - Bianco**  
White - Blanc

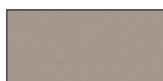

**MTR - Tortora**  
Dove - Gris taupe

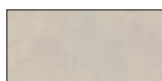

**MCE - Cemento**  
Concrete - Béton  
**TEXTURE MATERICA**  
**TEXTURED EFFECT**



**MOB - Olmo chiaro**  
Light elm  
Orme clair



**MRO - Rovere**  
Oak - Chêne



**MNC - Noce**  
Walnut - Noyer



**MFN - Frassino nero**  
Black ash  
Frêne noir



**MNV - Nero velluto**  
Black velvet  
Velours noir

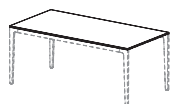

sp./th. 18 mm

### F - Fenix - Fenix - Fenix



**FEBI - Bianco**  
White - Blanc



**FENE - Nero**  
Black - Noir

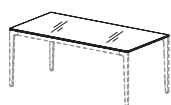

sp./th. 10 mm

### VT - Vetro verniciato lato inferiore - Painted under side glass - Verre verni côté inférieur

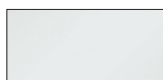

**VTBI - Vetro verniciato bianco**  
White painted glass  
Verre verni blanc

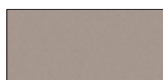

**VTR - Vetro verniciato tortora**  
Dove painted glass  
Verre verni gris taupe



**VTNE - Vetro verniciato nero**  
Black painted glass  
Verre verni noir

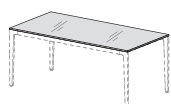

sp./th. 10 mm

### VV - Vetro acidato lato superiore, verniciato lato inferiore - Etched glass upper side, painted under side - Verre dépoli en côté supérieur et verni en côté inférieur

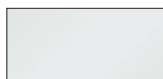

**VBI - Vetro verniciato bianco**  
White painted glass  
Verre verni blanc

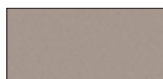

**VTR - Vetro verniciato tortora**  
Dove painted glass  
Verre verni gris taupe

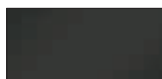

**VNE - Vetro verniciato nero**  
Black painted glass  
Verre verni noir

# Segrino

## Gonna

Modesty panel

Voile de fond

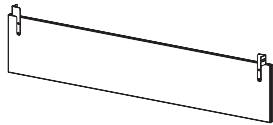

### M - Melaminico - Melamine - Mélamine

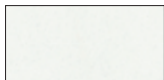

**MBI - Bianco**  
White - Blanc

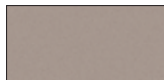

**MTR - Tortora**  
Dove - Gris taupe

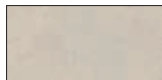

**MCE - Cemento**  
Concrete - Béton  
**TEXTURE MATERICA**  
**TEXTURED EFFECT**

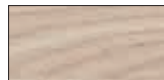

**MOB - Olmo chiaro**  
Light elm  
Orme clair



**MRO - Rovere**  
Oak - Chêne



**MNC - Noce**  
Walnut - Noyer



**MFN - Frassino nero**  
Black ash  
Frêne noir



**MNV - Nero velluto**  
Black velvet  
Velours noir

### MET - Metallo - Metal - Métal

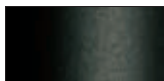

**ZGNE - Verniciato goffrato nero**  
Black embossed painted  
Verni gaufré noir  
RAL 9005

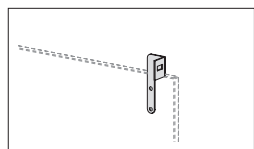

## Sottomano in ecopelle - Cat. D (Skill)

Eco-leather desk pad - Cat. D (Skill)

Sous-main en simili-cuir - Cat. D (Skill)



### Cat. D (Skill) - Ecopelle - Eco-leather - Simili-cuir



Cat. D - Skill

# Segrino

Mobile di servizio portante  
Supporting service unit  
Meuble de service portant

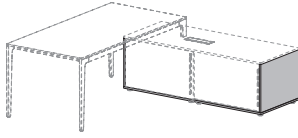

## M - Scocca in melaminico - Melamine structure - Structure en mélamine

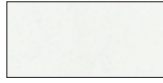

**MBI - Bianco**  
White - Blanc



**MTR - Tortora**  
Dove - Gris taupe



**MCE - Cemento**  
Concrete - Béton  
**TEXTURE MATERICA**  
TEXTURED EFFECT



**MOB - Olmo chiaro**  
Light elm  
Orme clair



**MRO - Rovere**  
Oak - Chêne



**MNC - Noce**  
Walnut - Noyer



**MFN - Frassino nero**  
Black ash  
Frêne noir



**MNV - Nero velluto**  
Black velvet  
Velours noir

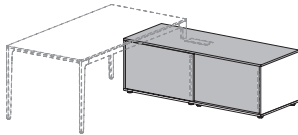

## M - Frontali in melaminico - Melamine fronts - Façades en mélamine



**MBI - Bianco**  
White - Blanc



**MTR - Tortora**  
Dove - Gris taupe

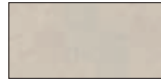

**MCE - Cemento**  
Concrete - Béton  
**TEXTURE MATERICA**  
TEXTURED EFFECT



**MOB - Olmo chiaro**  
Light elm  
Orme clair



**MRO - Rovere**  
Oak - Chêne



**MNC - Noce**  
Walnut - Noyer



**MFN - Frassino nero**  
Black ash  
Frêne noir



**MNV - Nero velluto**  
Black velvet  
Velours noir

# Segrino

## Elementi interni mobile di servizio

Internal elements for service unit

Éléments intérieurs pour meuble de service

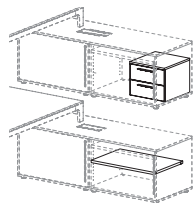

### M - Melaminico - Melamine - Mélamine



**MBI - Bianco**  
White - Blanc

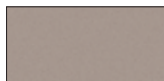

**MTR - Tortora**  
Dove - Gris taupe

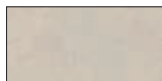

**MCE - Cemento**  
Concrete - Béton  
**TEXTURE MATERICA**  
**TEXTURED EFFECT**



**MOB - Olmo chiaro**  
Light elm  
Orme clair



**MRO - Rovere**  
Oak - Chêne



**MNC - Noce**  
Walnut - Noyer



**MFN - Frassino nero**  
Black ash  
Frêne noir



**MNV - Nero velluto**  
Black velvet  
Velours noir

## Maniglia in ABS (PL - Plastic)

ABS handle (PL - Plastic)

Poignée en ABS (PL - Plastic)



### PL - Plastica - Plastic - Plastique

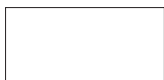

**BI - Bianco**  
White - Blanc  
**RAL 9010**

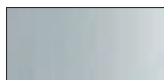

**AO - Alluminio**  
Aluminium  
Aluminium



**NE - Nero**  
Black - Noir  
**RAL 9005**

## Maniglia in metallo (Metal)

Metal handle (Metal)

Poignée en métal (Metal)

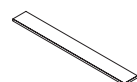

### MET - Metallo - Metal - Métal



**BI - Bianco**  
White - Blanc  
**RAL 9010**



**AO - Alluminio**  
Aluminium  
Aluminium



**NE - Nero**  
Black - Noir  
**RAL 9005**



**CR - Cromo lucido**  
Polished chrome  
Chrome poli

## Contenitori

Cabinets

Meubles

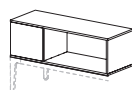

### M - Melaminico - Melamine - Mélamine

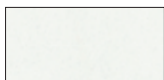

**MBI - Bianco**  
White - Blanc

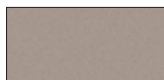

**MTR - Tortora**  
Dove - Gris taupe

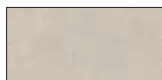

**MCE - Cemento**  
Concrete - Béton  
**TEXTURE MATERICA**  
**TEXTURED EFFECT**



**MOB - Olmo chiaro**  
Light elm  
Orme clair



**MRO - Rovere**  
Oak - Chêne

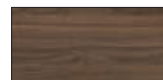

**MNC - Noce**  
Walnut - Noyer



**MFN - Frassino nero**  
Black ash  
Frêne noir



**MNV - Nero velluto**  
Black velvet  
Velours noir

# Segrino

**Muretto passaggio cavi**  
Cable tower leg  
Pied pour passage des câbles

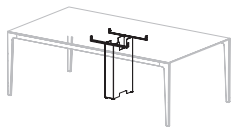

**AL - Alluminio** - Aluminium - Aluminium

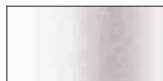

**ZGBI - Verniciato goffrato bianco**  
White embossed painted  
Verni gaufré blanc  
**RAL 9010**



**ZGTR - Verniciato goffrato tortora**  
Dove embossed painted  
Verni gaufré gris taupe

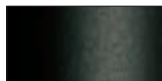

**ZGNE - Verniciato goffrato nero**  
Black embossed painted  
Verni gaufré noir  
**RAL 9005**

**Inserto centrale per tavolo riunione**  
Central insert for meeting table  
Insert central pour table réunion

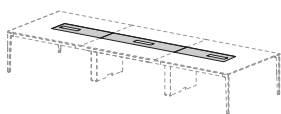

**M - Melaminico** - Melamine - Mélamine

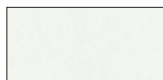

**MBI - Bianco**  
White - Blanc

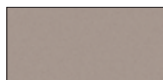

**MTR - Tortora**  
Dove - Gris taupe

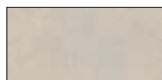

**MCE - Cemento**  
Concrete - Béton  
**TEXTURE MATERICA TEXTURED EFFECT**



**MOB - Olmo chiaro**  
Light elm  
Orme clair



**MRO - Rovere**  
Oak - Chêne

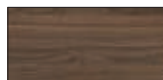

**MNC - Noce**  
Walnut - Noyer



**MFN - Frassino nero**  
Black ash  
Frêne noir



**MNV - Nero velluto**  
Black velvet  
Velours noir

**LA - Laccato opaco** - Matt lacquered - Laqué mat



**LAW1 - Bianco**  
White - Blanc  
**RAL 9016**



**LAG0 - Grigio ghiaia**  
Pebble grey  
Gris cailloux  
**RAL 7032**



**LAG5 - Grigio verdastro**  
Green grey  
Gris verdâtre  
**RAL 7009**



**LANE - Nero**  
Black - Noir  
**RAL 9011**

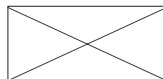

**LA99 - Colore cliente**  
Custom color  
Couleur personnalisée client

**Cat. D (Skill) - Ecopelle** - Eco-leather - Simili-cuir



Cat. D - Skill

# Segrino

## Vasca cablaggio per scrivania

Desk cable tray

Goulotte câblage pour bureau



**MET - Metallo** - Metal - Métal

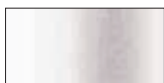

**ZGBI - Verniciato goffrato bianco**  
White embossed painted  
Verni gaufré blanc  
RAL 9010

**ZGNE - Verniciato goffrato nero**  
Black embossed painted  
Verni gaufré noir  
RAL 9005

## Vasca cablaggio regolabile in altezza (H. 12,5 ÷ 15,4 cm) per bench

Height-adjustable cable tray (H. 4"7/8 ÷ 6"1/8) for bench desk

Goulotte câblage réglable en hauteur (Ht. 12,5 ÷ 15,4 cm) pour bureau double

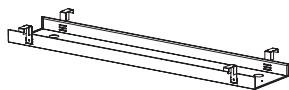

**MET - Metallo** - Metal - Métal

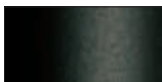
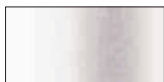

**ZGBI - Verniciato goffrato bianco**  
White embossed painted  
Verni gaufré blanc  
RAL 9010

**ZGNE - Verniciato goffrato nero**  
Black embossed painted  
Verni gaufré noir  
RAL 9005

## Vertebra passacavi

Vertical cable duct

Passe-câbles vertical

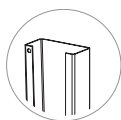
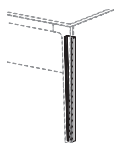

**AL9237**

**MET - Metallo** - Metal - Métal

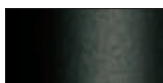
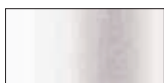

**ZGBI - Verniciato goffrato bianco**  
White embossed painted - Verni gaufré blanc  
RAL 9010

**ZGTR - Verniciato goffrato tortora**  
Dove embossed painted  
Verni gaufré gris taupe

**ZGNE - Verniciato goffrato nero**  
Black embossed painted  
Verni gaufré noir  
RAL 9005

## Vertebra passacavi in tessuto - Chiusura a zip

Fabric vertical cable duct - Zip closure

Passe-câbles vertical en tissu - Fermeture à glissière

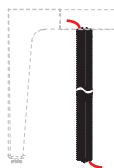

**T - Tessuto** - Fabric - Tissu



**GR - GR**  
Grey - Gris

**NE - NE**  
Black - Noir

## Staffa per multipresa

Multisocket bracket

Support pour multi-prise

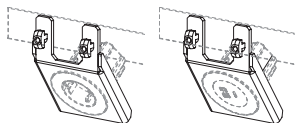

**AL - Alluminio** - Aluminium - Aluminium

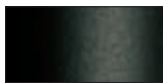
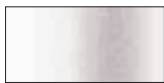

**ZGBI - Verniciato goffrato bianco**  
White embossed painted  
Verni gaufré blanc  
RAL 9010

**ZGTR - Verniciato goffrato tortora**  
Dove embossed painted  
Verni gaufré gris taupe

**ZGNE - Verniciato goffrato nero**  
Black embossed painted  
Verni gaufré noir  
RAL 9005

# Segrino

**Dati tecnici**  
 Technical data  
 Données techniques

**Scrivania**  
 Desk  
 Bureau

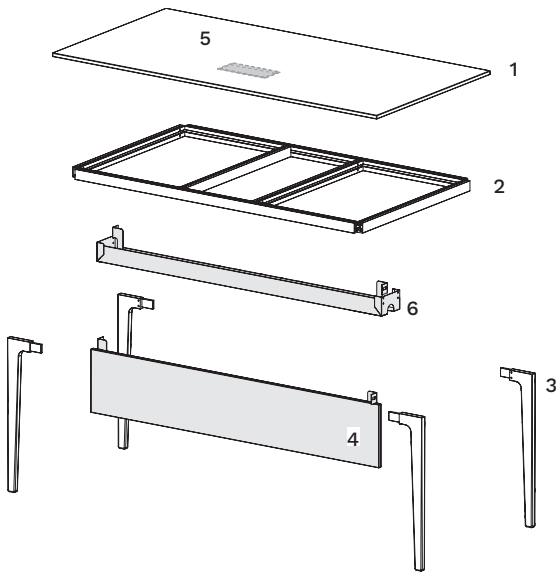

- 1. Piano**  
Top  
Plateau
- 2. Telaio perimetrale**  
Perimeter frame  
Châssis périmétrique
- 3. Gambe**  
Legs  
Piètements
- OPTIONS**
- 4. Gonna**  
Modesty panel  
Voile de fond
- 5. Flap**  
Top access  
Top access
- 6. Vasca cablaggio**  
Cable tray  
Goulotte câblage

**Lato visitatore - Scrivania p. 80 cm**  
 Visitor side - D. 31"1/2 desk  
 Côté visiteur - Bureau p. 80 cm

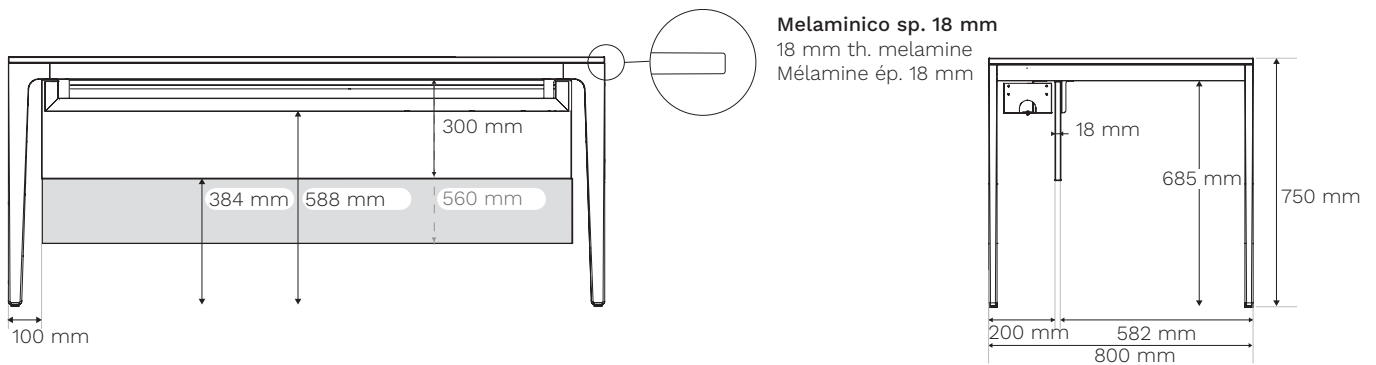

**Lato visitatore - Scrivania p. 90 cm**  
 Visitor side - D. 35"3/8 desk  
 Côté visiteur - Bureau p. 90 cm

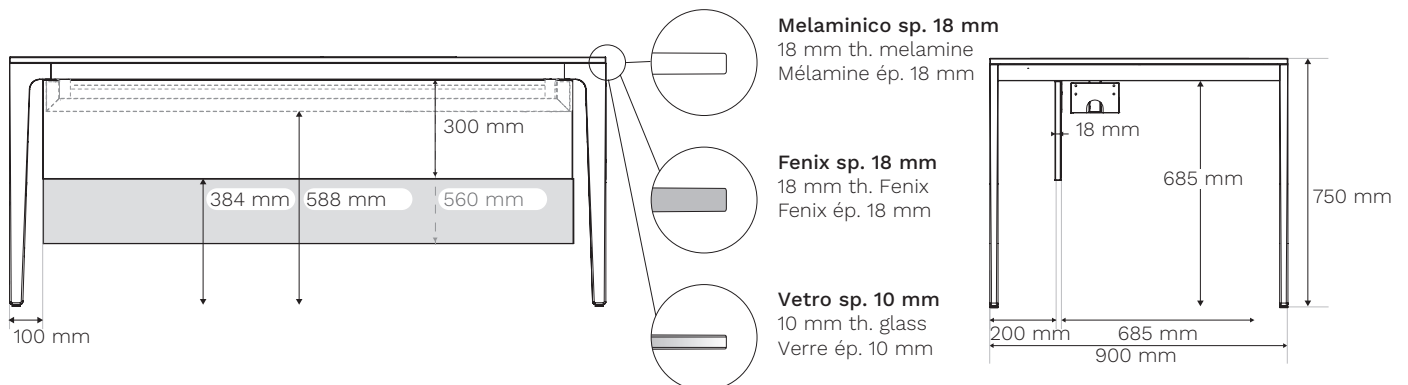

# Segrino

## Posizioni flap per scrivania

Top access positions for desk

Positions du top access pour bureau

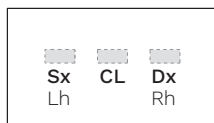

cod. EEFL41



metal

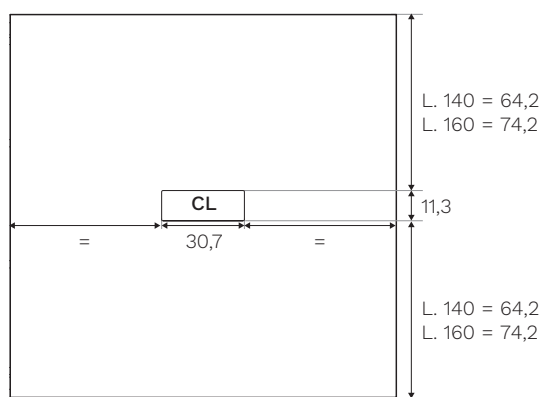
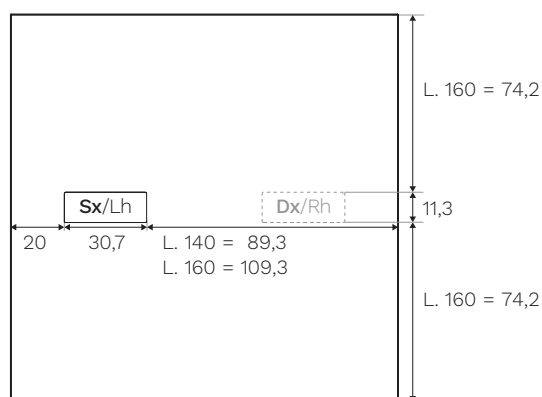
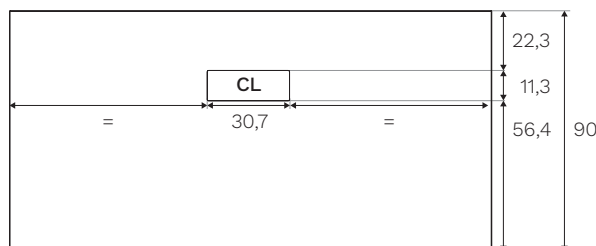
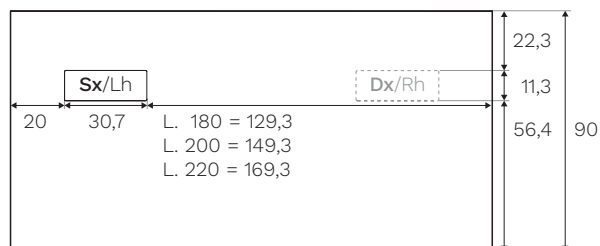
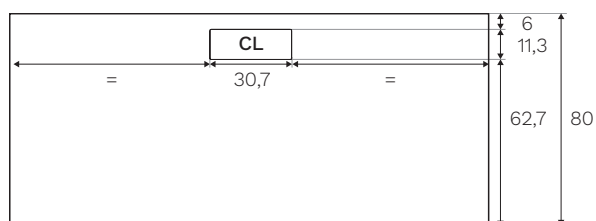
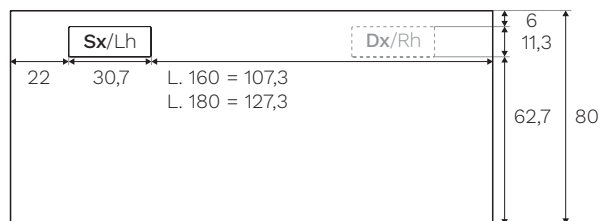

## Posizioni Versaturn 3.0 per scrivania

Versaturn 3.0 position for desk

Position Versaturn 3.0 pour bureau

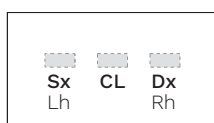

cod. EEFM09 VERSATURN 3.0

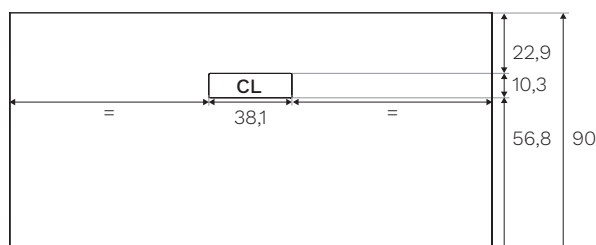
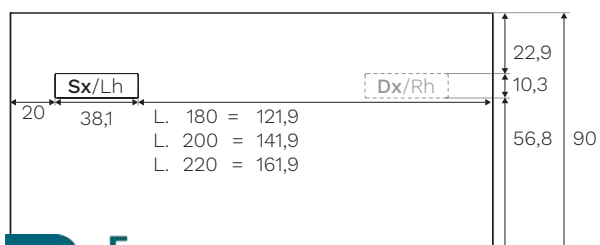
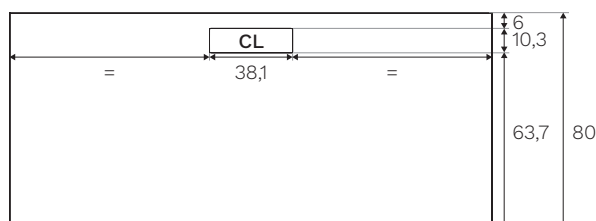
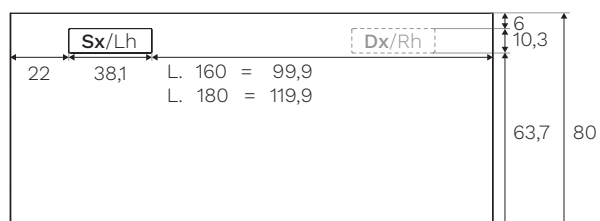

# Segrino

Mobile di servizio portante L. 125 cm  
 W. 49"1/4 supporting service unit  
 Meuble de service portant L. 125 cm

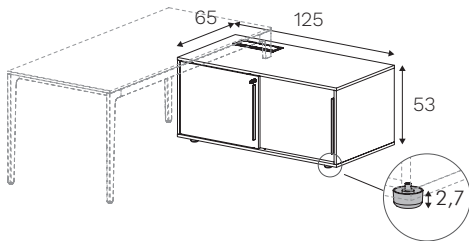

**Ripiano spostabile**  
 Movable shelf  
 Étagère amovible  
 sp./th./ép. 18 mm

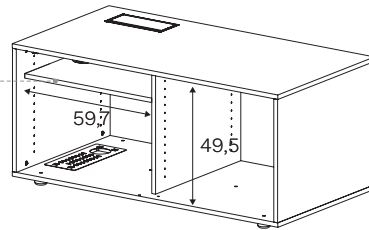

**Posizione mobile di servizio**  
 Service unit position  
 Position meuble de service

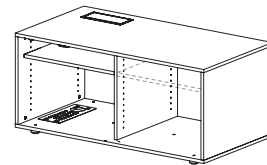
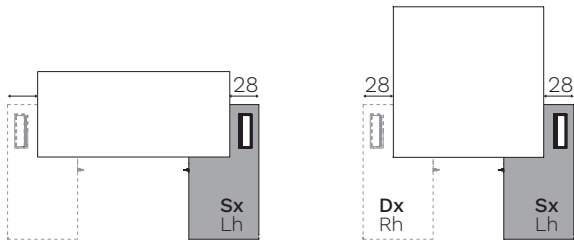

## OPTIONS

### PPR059

**Ripiano spostabile sp. 18 mm**  
 18 mm th. movable shelf  
 Étagère amovible ép. 18 mm

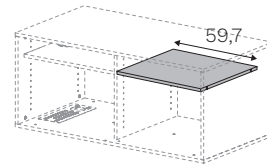

### CS835

**Cassettiera 2 cassetti in metallo**  
 2 metal drawers pedestal  
 Caisson 2 tiroirs en métal

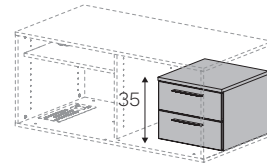

### CS836

**Cassettiera 3 cassetti rivestiti in PVC**  
 3 PVC-coated drawers pedestal  
 Caisson 3 tiroirs en PVC

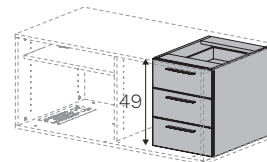

### CS837

**Cassettiera 1 cassetto in metallo + 1 Classificatore in metallo**  
 1 metal drawer + 1 metal filing drawer pedestal  
 Caisson avec 1 tiroir en métal + 1 tiroir DS en métal

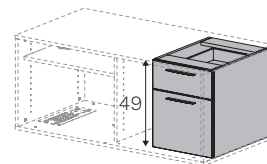

## FONDO / BOTTOM / BASE

**Griglia uscita cavi inclusa**  
 Cable outlet grid included  
 Grille de sorties de câbles incluse

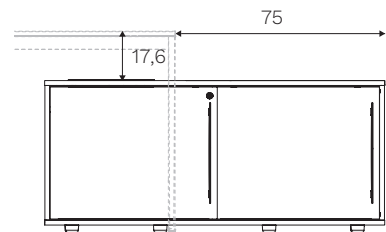
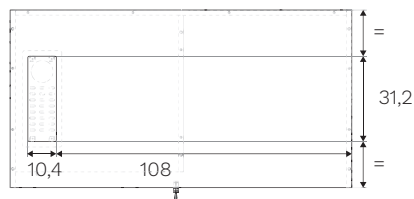
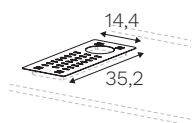

## TOP / TOP / DESSUS

**Flap incluso**  
 Top access included  
 Top access incluse

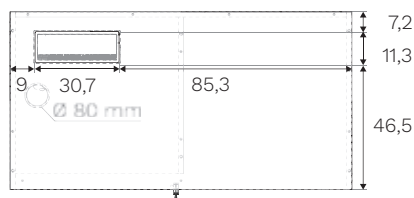
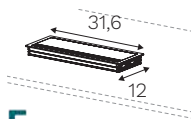

**Serratura centralizzata**  
 Centralized lock  
 Serrure centralisée

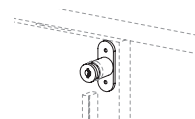

# Segrino

Mobile di servizio portante L. 165 cm  
 W. 65" supporting service unit  
 Meuble de service portant L. 165 cm

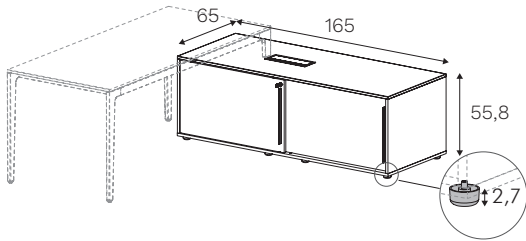

**Ripiano spostabile**  
 Movable shelf  
 Étagère amovible  
 sp./th./ép. 18 mm

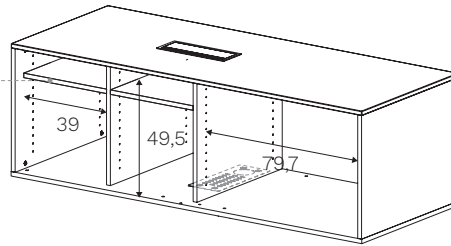

**Posizione mobile di servizio**  
 Service unit position  
 Position meuble de service

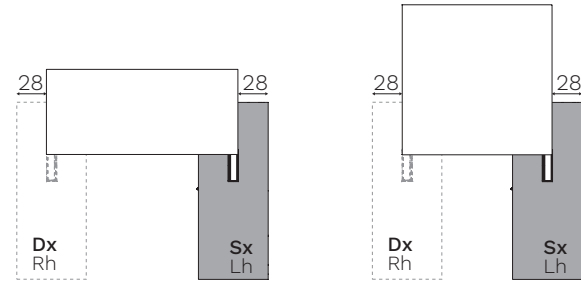

## OPTIONS

### PPR080

**Ripiano spostabile sp. 18 mm**  
 18 mm th. movable shelf  
 Étagère amovible ép. 18 mm

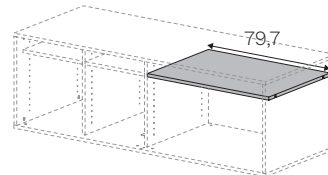
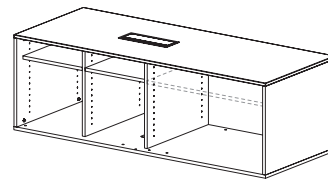

### CS835

**Cassettiera 2 cassetti in metallo**  
 2 metal drawers pedestal  
 Caisson 2 tiroirs en métal

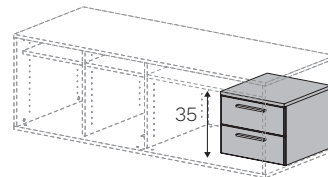

### CS836

**Cassettiera 3 cassetti rivestiti in PVC**  
 3 PVC-coated drawers pedestal  
 Caisson 3 tiroirs en PVC

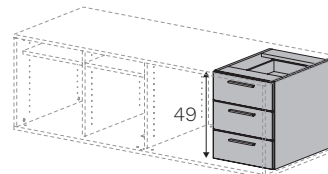

### CS837

**Cassettiera 1 cassetto in metallo + 1 Classificatore in metallo**  
 1 metal drawer + 1 metal filing drawer pedestal  
 Caisson avec 1 tiroir en métal + 1 tiroir DS en métal

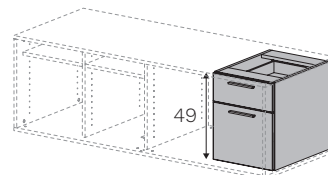

## FONDO / BOTTOM / BASE

**Griglia uscita cavi inclusa**  
 Cable outlet grid included  
 Grille de sorties de câbles incluse

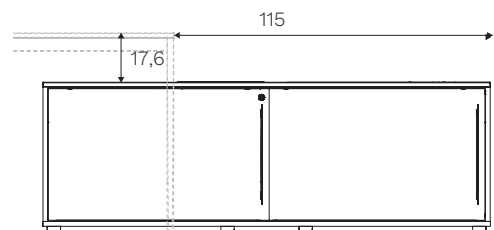
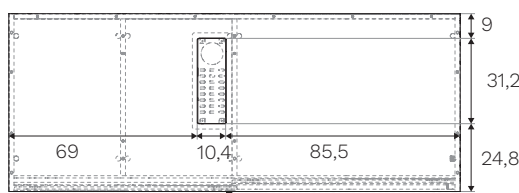
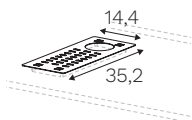

## TOP / TOP / DESSUS

**Flap incluso**  
 Top access included  
 Top access incluse

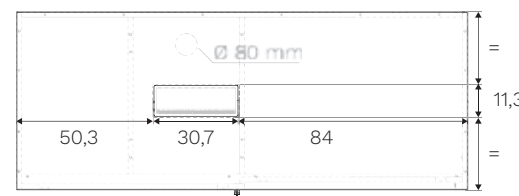
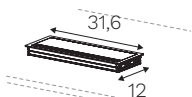

**Serratura centralizzata**  
 Centralized lock  
 Serrure centralisée

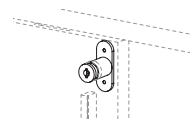

# Segrino

## Posizioni flap per tavoli riunione P. 120 cm

Top access positions for D. 47"1/4 meeting tables

Positions du top access pour tables de réunion P. 120 cm

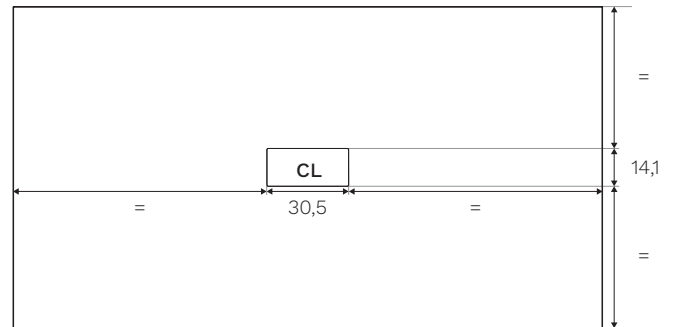
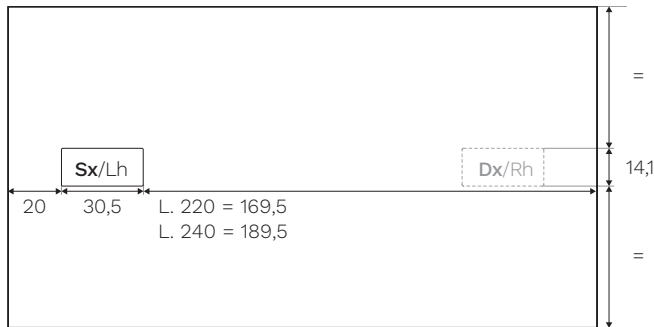
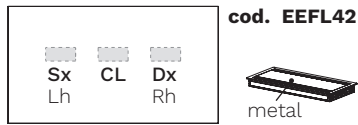

## Posizione flap per tavoli riunione in composizione

Top access position for meeting tables in compositions

Position du top access pour tables de réunion en composition

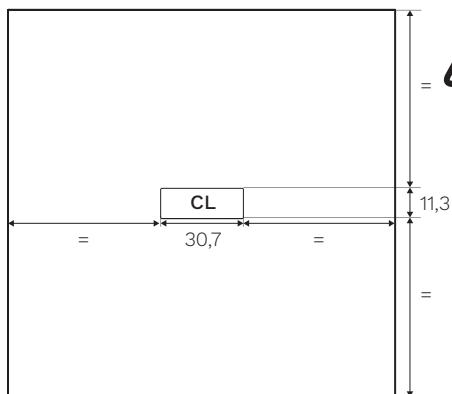
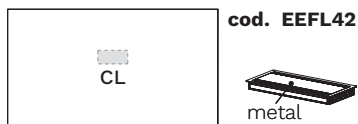

**Tavoli riunione per composizioni**  
Meeting tables for compositions  
Tables réunion pour compositions

## Posizioni VERSATURN 3.0 per tavoli riunione

VERSATURN 3.0 positions for meeting tables

Positions VERSATURN 3.0 pour tables de réunion

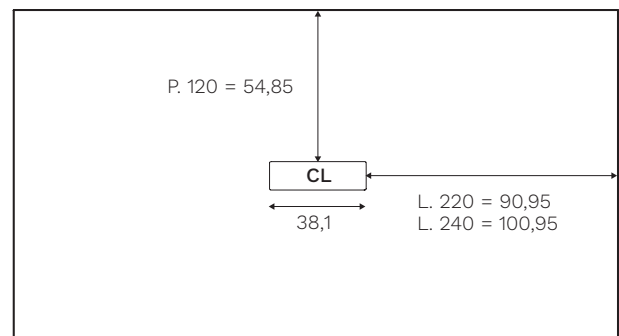
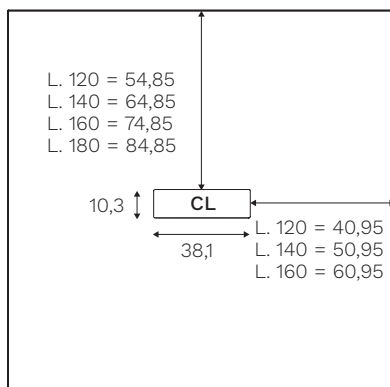
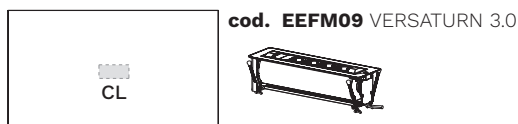





# Segrino

## Flap + vasca di cablaggio per tavoli riunione

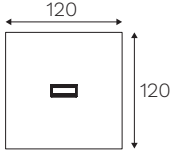
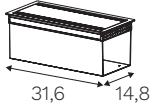
Top access + cable tray for meeting tables

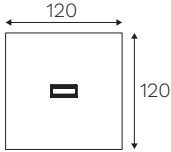
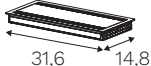
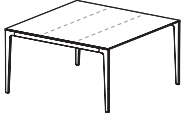
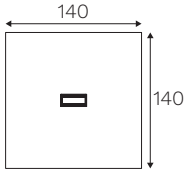
Top access + goulotte câblage pour tables de réunion

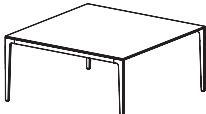
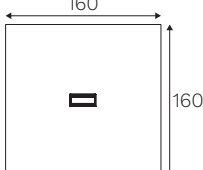
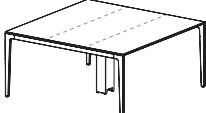
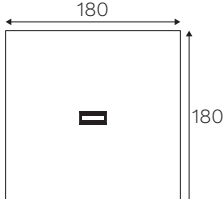
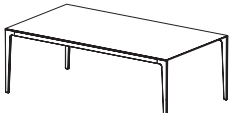
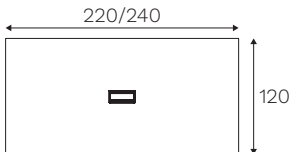
	<p><b>OPTIONS</b></p> <p>(1x) APP + (1x) <b>Cod. EEFL42</b> + (1x) <b>Cod. EEFL44</b>  <b>Foratura per piano + Flap + Vasca cablaggio</b>            Drilling for top + Top access + Cable tray            Perçage pour plateau + Top access + Goulotte câblage</p> 	<p><b>Cod. EEFL42 + Cod. EEFL44</b>  <b>Flap + Vasca cablaggio</b>            Top access + Cable tray            Top access + Goulotte câblage</p> 
	<p>(1x) APP + (1x) <b>Cod. EEFL42</b> + (1x) <b>Cod. AL9212</b>  <b>Foratura per piano + Flap + Vasca cablaggio</b>            Drilling for top + Top access + Cable tray            Perçage pour plateau + Top access + Goulotte câblage</p> 	<p><b>Cod. EEFL42</b>  <b>Flap</b>            Top access            Top access</p> 
	<p>(1x) APP + (1x) <b>Cod. EEFL42</b> + (1x) <b>Cod. AL9214</b>  <b>Foratura per piano + Flap + Vasca cablaggio</b>            Drilling for top + Top access + Cable tray            Perçage pour plateau + Top access + Goulotte câblage</p> 	<p><b>Cod. AL92_ _</b>  <b>Vasca cablaggio</b>            Cable tray            Goulotte câblage</p> 
	<p>(1x) APP + (1x) <b>Cod. EEFL42</b> + (1x) <b>Cod. AL9216</b>  <b>Foratura per piano + Flap + Vasca cablaggio</b>            Drilling for top + Top access + Cable tray            Perçage pour plateau + Top access + Goulotte câblage</p> 	
	<p>(1x) APP + (1x) <b>Cod. EEFL42</b> + (1x) <b>Cod. AL9218</b>  <b>Foratura per piano + Flap + Vasca cablaggio</b>            Drilling for top + Top access + Cable tray            Perçage pour plateau + Top access + Goulotte câblage</p> 	
	<p>(1x) APP + (1x) <b>Cod. EEFL42</b> + (1x) <b>Cod. AL9222</b>  <b>Foratura per piano + Flap + Vasca cablaggio</b>            Drilling for top + Top access + Cable tray            Perçage pour plateau + Top access + Goulotte câblage</p> 	

# Segrino

## Flap + vasca di cablaggio per tavoli riunione

Top access + cable tray for meeting tables

Top access + goulotte câblage pour tables de réunion

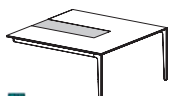
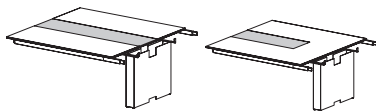
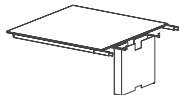
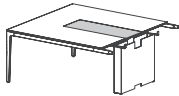
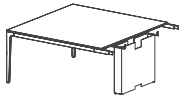
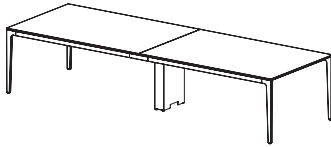
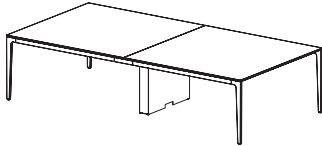
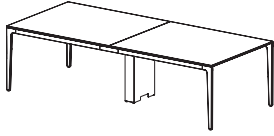

### OPTIONS

(2x) APP + (2x) Cod. EEFL42 + (2x) Cod. AL9210

Foratura per piano + Flap + Vasca cablaggio

Drilling for top + Top access + Cable tray

Perçage pour plateau + Top access + Goulotte câblage

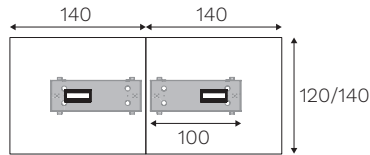

(2x) APP + (2x) Cod. EEFL42 + (2x) Cod. AL9211

Foratura per piano + Flap + Vasca cablaggio

Drilling for top + Top access + Cable tray

Perçage pour plateau + Top access + Goulotte câblage

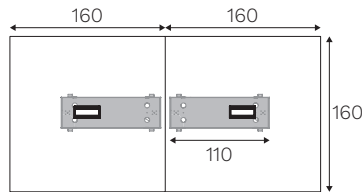

(2x) APP + (2x) Cod. EEFL42 + (2x) Cod. AL9214

Foratura per piano + Flap + Vasca cablaggio

Drilling for top + Top access + Cable tray

Perçage pour plateau + Top access + Goulotte câblage

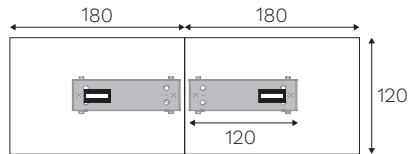

(1x) APP + (1x) Cod. EEFL42 + (1x) Cod. \*

Foratura per piano + Flap + Vasca cablaggio

Drilling for top + Top access + Cable tray

Perçage pour plateau + Top access + Goulotte câblage

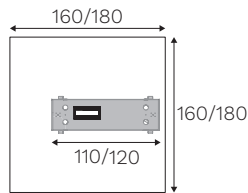

\*  
Mod. 160  
Cod. AL9211

Mod. 180  
Cod. AL9214

(1x) APP + (1x) Cod. EEFL42 + (1x) Cod. \*

Foratura per piano + Flap + Vasca cablaggio

Drilling for top + Top access + Cable tray

Perçage pour plateau + Top access + Goulotte câblage

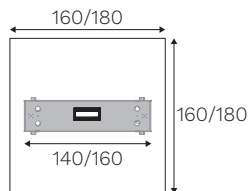

\*  
Mod. 160  
Cod. AL9216

Mod. 180  
Cod. AL9218

(1x) APP + (1x) Cod. EEFL42 + (1x) Cod. \*

Foratura per piano + Flap + Vasca cablaggio

Drilling for top + Top access + Cable tray

Perçage pour plateau + Top access + Goulotte câblage

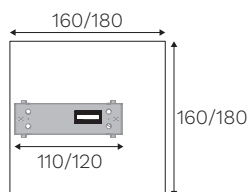

\*  
Mod. 160  
Cod. AL9211

Mod. 180  
Cod. AL9214

Cod. EEFL42

Flap

Top access

Top access



Cod. AL92\_ \_

Vasca cablaggio

Cable tray

Goulotte câblage



# Segrino

Tavoli riunione in composizione con inserto centrale

Meeting tables in composition with central insert

Tables de réunion en composition avec insert central

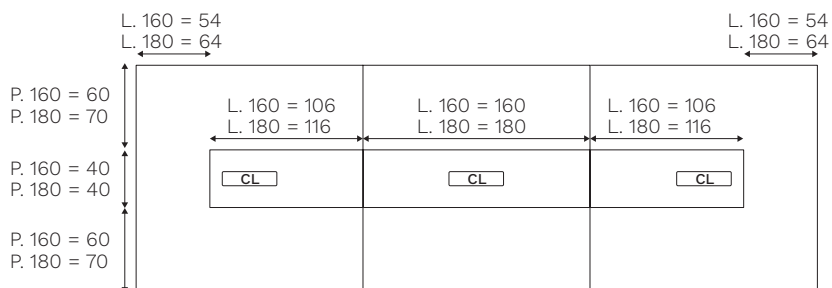
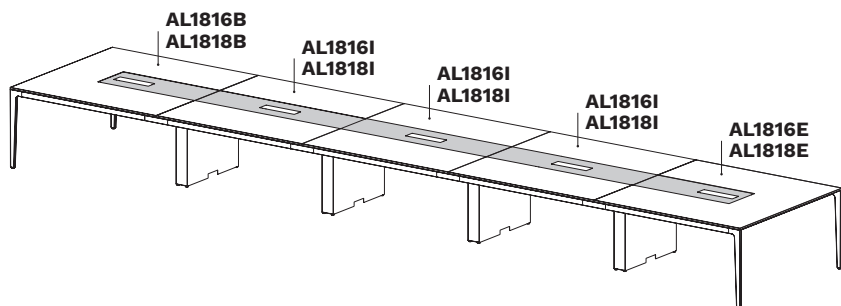
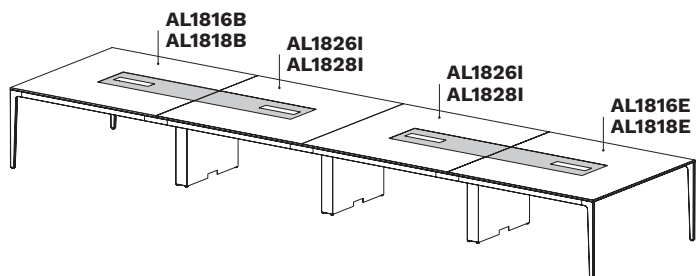
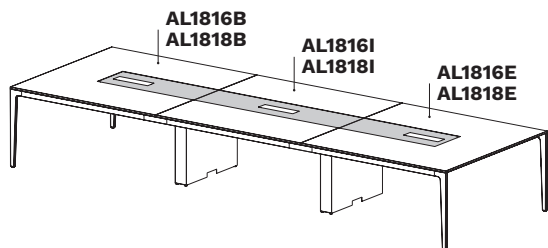
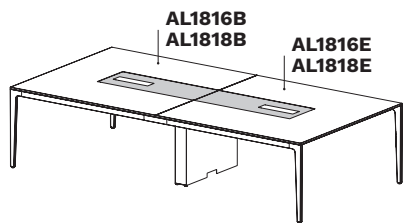

# Segrino

## Scrivania - Piano: melaminico (M), Fenix (F)

Desk - Top: melamine (M), Fenix (F)

Bureau - Plateau: mélamine (M), Fenix (F)



L. W.	P. D.	H. H.	COD.	kg lb	m <sup>3</sup> ft <sup>3</sup>
180 70 <sup>7</sup> / <sub>8</sub>	90 35 <sup>3</sup> / <sub>8</sub>	75 29 <sup>1</sup> / <sub>2</sub>	<b>AL0518</b>	47,01 104.00	0,118 4.18
200 78 <sup>3</sup> / <sub>4</sub>	90 35 <sup>3</sup> / <sub>8</sub>	75 29 <sup>1</sup> / <sub>2</sub>	<b>AL0520</b>	50,13 111.00	0,129 4.54
220 86 <sup>5</sup> / <sub>8</sub>	90 35 <sup>3</sup> / <sub>8</sub>	75 29 <sup>1</sup> / <sub>2</sub>	<b>AL0522</b>	53,14 117.00	0,139 4.90
140 55 <sup>1</sup> / <sub>8</sub>	80 31 <sup>1</sup> / <sub>2</sub>	75 29 <sup>1</sup> / <sub>2</sub>	<b>AL0554</b>	37,00 81.60	0,090 3.16
160 63"	80 31 <sup>1</sup> / <sub>2</sub>	75 29 <sup>1</sup> / <sub>2</sub>	<b>AL0556</b>	39,78 87.70	0,100 3.52
180 70 <sup>7</sup> / <sub>8</sub>	80 31 <sup>1</sup> / <sub>2</sub>	75 29 <sup>1</sup> / <sub>2</sub>	<b>AL0558</b>	42,57 93.80	0,109 3.83

<b>Maggiorazioni</b> - Supplement - Supplement					
<b>Foratura per piano melaminico/fenix per 1 flap (non incluso)</b> Drilling melamine/fenix top for 1 top access (not included) Perçage plateau en mélamine/fenix pour 1 top access (pas inclus)	<b>APP</b>				
<b>Foratura piano melaminico/fenix per VERSATURN (non incluso)</b> Drilling for melamine/fenix top for VERSATURN (not included) Perçage plateau en mélamine/fenix pour VERSATRUN (pas inclus)	<b>APP</b>				

## Consolle - Piano: melaminico (M), Fenix (F)

Console - Top: melamine (M), Fenix (F)

Console - Plateau: mélamine (M), Fenix (F)



L. W.	P. D.	H. H.	COD.	kg lb	m <sup>3</sup> ft <sup>3</sup>
200 78 <sup>3</sup> / <sub>4</sub>	60 23 <sup>5</sup> / <sub>8</sub>	75 29 <sup>1</sup> / <sub>2</sub>	<b>AL0420</b>	39,71 87.50	0,095 3.36

## Allungo appeso - Piano: melaminico (M), Fenix (F)

Hanging return top - Top: melamine (M), Fenix (F)

Retour suspendu - Plateau: mélamine (M), Fenix (F)



L. W.	P. D.	H. H.	COD.	kg lb	m <sup>3</sup> ft <sup>3</sup>
80 31 <sup>1</sup> / <sub>2</sub>	60 23 <sup>5</sup> / <sub>8</sub>	75 29 <sup>1</sup> / <sub>2</sub>	<b>AL1408</b>	18,44 40.60	0,046 1.62
100 39 <sup>3</sup> / <sub>8</sub>	60 23 <sup>5</sup> / <sub>8</sub>	75 29 <sup>1</sup> / <sub>2</sub>	<b>AL1410</b>	21,56 47.50	0,054 1.90

### APP = Posizione flap per scrivania

Top access position for desk

Position du top access pour bureau

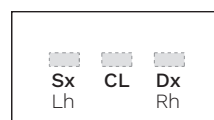

cod. **EEFL41**



metal

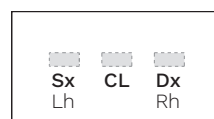

cod. **EEFM09** VERSATURN 3.0



# Segrino

## Scrivania - Piano in vetro verniciato lato inferiore (VTNE-VTBI-VTTR)

Desk - Painted under side glass top (VTNE-VTBI-VTTR)

Bureau - Plateau en verre verni côté inférieur (VTNE-VTBI-VTTR)

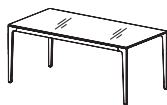

L. W.	P. D.	H. H.	COD.	kg lb	m <sup>3</sup> ft <sup>3</sup>
180 70 <sup>7</sup> / <sub>8</sub>	90 35 <sup>3</sup> / <sub>8</sub>	75 29 <sup>1</sup> / <sub>2</sub>	<b>AL0518V</b>	74,61 164.00	0,105 3.70
200 78 <sup>3</sup> / <sub>4</sub>	90 35 <sup>3</sup> / <sub>8</sub>	75 29 <sup>1</sup> / <sub>2</sub>	<b>AL0520V</b>	80,73 178.00	0,113 4.00
220 86 <sup>5</sup> / <sub>8</sub>	90 35 <sup>3</sup> / <sub>8</sub>	75 29 <sup>1</sup> / <sub>2</sub>	<b>AL0522V</b>	86,84 191.00	0,122 4.31

Maggiorazioni - Supplement - Supplément

**Foratura per piano vetro per 1 flap (non incluso)**

Drilling for glass top for 1 top access (not included)

Perçage pour plateau en verre pour 1 top access (pas inclus)

**APP**

**Foratura piano vetro per VERSATURN (non incluso)**

Drilling for glass top for VERSATURN (not included)

Perçage plateau en verre pour VERSATRUN (pas inclus)

**APP**

## Consolle - Piano in vetro verniciato lato inferiore (VTNE-VTBI-VTTR)

Console - Painted under side glass top (VTNE-VTBI-VTTR)

Console - Plateau en verre verni côté inférieur (VTNE-VTBI-VTTR)

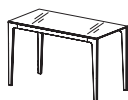

L. W.	P. D.	H. H.	COD.	kg lb	m <sup>3</sup> ft <sup>3</sup>
200 78 <sup>3</sup> / <sub>4</sub>	60 23 <sup>5</sup> / <sub>8</sub>	75 29 <sup>1</sup> / <sub>2</sub>	<b>AL0420V</b>	60,11 133.00	0,086 3.02

## Allungo appeso - Piano in vetro verniciato lato inferiore (VTNE-VTBI-VTTR)

Hanging return top - Painted under side glass top (VTNE-VTBI-VTTR)

Retour suspendu - Plateau en verre verni côté inférieur (VTNE-VTBI-VTTR)



L. W.	P. D.	H. H.	COD.	kg lb	m <sup>3</sup> ft <sup>3</sup>
100 39 <sup>3</sup> / <sub>8</sub>	60 23 <sup>5</sup> / <sub>8</sub>	75 29 <sup>1</sup> / <sub>2</sub>	<b>AL1410V</b>	32,76 72.20	0,049 1.74

# Segrino

## Scrivania - Piano in vetro acidato lato superiore, verniciato lato inferiore (VNE-VBI-VTR)

Desk - Etched glass upper side, painted under side top (VNE-VBI-VTR)

Bureau - Plateau en verre dépoli en côté supérieur et verni en côté inférieur (VNE-VBI-VTR)



L. W.	P. D.	H. H.	COD.	kg lb	m <sup>3</sup> ft <sup>3</sup>
180 70 <sup>7</sup> / <sub>8</sub>	90 35 <sup>3</sup> / <sub>8</sub>	75 29 <sup>1</sup> / <sub>2</sub>	<b>AL0518V</b>	74,61 164.00	0,105 3.70
200 78 <sup>3</sup> / <sub>4</sub>	90 35 <sup>3</sup> / <sub>8</sub>	75 29 <sup>1</sup> / <sub>2</sub>	<b>AL0520V</b>	80,73 178.00	0,113 4.00
220 86 <sup>5</sup> / <sub>8</sub>	90 35 <sup>3</sup> / <sub>8</sub>	75 29 <sup>1</sup> / <sub>2</sub>	<b>AL0522V</b>	86,84 191.00	0,122 4.31

Maggiorazioni - Supplement - Supplement			
<b>Foratura per piano vetro per 1 flap (non incluso)</b> Drilling for glass top for 1 top access (not included) Perçage pour plateau en verre pour 1 top access (pas inclus)	<b>APP</b>		
<b>Foratura piano vetro per VERSATURN (non incluso)</b> Drilling for glass top for VERSATURN (not included) Perçage plateau en verre pour VERSATRUN (pas inclus)	<b>APP</b>		

## Consolle - Piano in vetro acidato lato superiore, verniciato lato inferiore (VNE-VBI-VTR)

Console - Etched glass upper side, painted under side top (VNE-VBI-VTR)

Console - Plateau en verre dépoli en côté supérieur et verni en côté inférieur (VNE-VBI-VTR)



L. W.	P. D.	H. H.	COD.	kg lb	m <sup>3</sup> ft <sup>3</sup>
200 78 <sup>3</sup> / <sub>4</sub>	60 23 <sup>5</sup> / <sub>8</sub>	75 29 <sup>1</sup> / <sub>2</sub>	<b>AL0420V</b>	60,11 133.00	0,086 3.02

## Allungo appeso - Piano in vetro acidato lato superiore, verniciato lato inferiore (VNE-VBI-VTR)

Hanging return top - Etched glass upper side, painted under side top (VNE-VBI-VTR)

Retour suspendu - Plateau en verre dépoli en côté supérieur et verni en côté inférieur (VNE-VBI-VTR)



L. W.	P. D.	H. H.	COD.	kg lb	m <sup>3</sup> ft <sup>3</sup>
100 39 <sup>3</sup> / <sub>8</sub>	60 23 <sup>5</sup> / <sub>8</sub>	75 29 <sup>1</sup> / <sub>2</sub>	<b>AL1410V</b>	32,76 72.20	0,049 1.74

### APP = Posizione flap per scrivania

Top access position for desk

Position du top access pour bureau

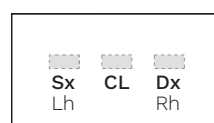

cod. EEFL41



metal

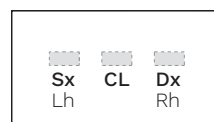

cod. EEFM09 VERSATURN 3.0

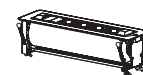

# Segrino

Scrivania appesa - Piano: melaminico (M), Fenix (F)

Hanging desk - Top: melamine (M), Fenix (F)

Bureau suspendu - Plateau: mélamine (M), Fenix (F)

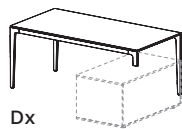

Dx  
Rh

	L. W.	P. D.	H. H.	COD.		kg lb	m <sup>3</sup> ft <sup>3</sup>
Dx Rh	180 70 <sup>7</sup> / <sub>8</sub>	90 35 <sup>3</sup> / <sub>8</sub>	75 29 <sup>1</sup> / <sub>2</sub>	<b>AL3518D</b>		46,19 102.00	0,124 4.39
	200 78 <sup>3</sup> / <sub>4</sub>	90 35 <sup>3</sup> / <sub>8</sub>	75 29 <sup>1</sup> / <sub>2</sub>	<b>AL3520D</b>		49,30 109.00	0,134 4.75
	220 86 <sup>5</sup> / <sub>8</sub>	90 35 <sup>3</sup> / <sub>8</sub>	75 29 <sup>1</sup> / <sub>2</sub>	<b>AL3522D</b>		52,32 115.00	0,145 5.11
Sx Lh	180 70 <sup>7</sup> / <sub>8</sub>	90 35 <sup>3</sup> / <sub>8</sub>	75 29 <sup>1</sup> / <sub>2</sub>	<b>AL3518S</b>		46,19 102.00	0,124 4.39
	200 78 <sup>3</sup> / <sub>4</sub>	90 35 <sup>3</sup> / <sub>8</sub>	75 29 <sup>1</sup> / <sub>2</sub>	<b>AL3520S</b>		49,30 109.00	0,134 4.75
	220 86 <sup>5</sup> / <sub>8</sub>	90 35 <sup>3</sup> / <sub>8</sub>	75 29 <sup>1</sup> / <sub>2</sub>	<b>AL3522S</b>		52,32 115.00	0,145 5.11
Dx Rh	140 55 <sup>1</sup> / <sub>8</sub>	80 31 <sup>1</sup> / <sub>2</sub>	75 29 <sup>1</sup> / <sub>2</sub>	<b>AL3564D</b>		36,17 79.70	0,095 3.37
	160 63"	80 31 <sup>1</sup> / <sub>2</sub>	75 29 <sup>1</sup> / <sub>2</sub>	<b>AL3566D</b>		38,95 85.90	0,105 3.72
	180 70 <sup>7</sup> / <sub>8</sub>	80 31 <sup>1</sup> / <sub>2</sub>	75 29 <sup>1</sup> / <sub>2</sub>	<b>AL3568D</b>		41,74 92.00	0,114 4.04
Sx Lh	140 55 <sup>1</sup> / <sub>8</sub>	80 31 <sup>1</sup> / <sub>2</sub>	75 29 <sup>1</sup> / <sub>2</sub>	<b>AL3564S</b>		36,17 79.70	0,095 3.37
	160 63"	80 31 <sup>1</sup> / <sub>2</sub>	75 29 <sup>1</sup> / <sub>2</sub>	<b>AL3566S</b>		38,95 85.90	0,105 3.72
	180 70 <sup>7</sup> / <sub>8</sub>	80 31 <sup>1</sup> / <sub>2</sub>	75 29 <sup>1</sup> / <sub>2</sub>	<b>AL3568S</b>		41,74 92.00	0,114 4.04

Maggiorazioni - Supplement - Supplement

Foratura per piano melaminico/fenix per 1 flap (non incluso)

Drilling melamine/fenix top for 1 top access (not included)  
Perçage plateau en mélamine/fenix pour 1 top access (pas inclus)

APP

Foratura piano melaminico/fenix per VERSATURN (non incluso)

Drilling for melamine/fenix top for VERSATRURN (not included)  
Perçage plateau en mélamine/fenix pour VERSATRURN (pas inclus)

APP

Posizione mobile di servizio

Service unit position

Position meuble de service

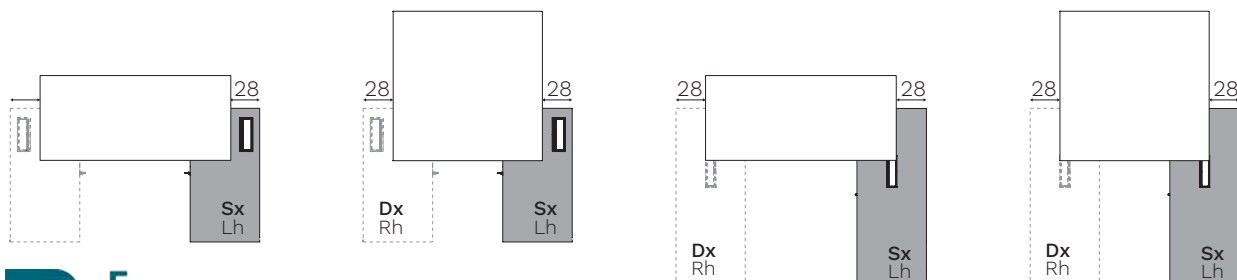

# Segrino

## Scrivania appesa - Piano in melaminico (M)

Hanging desk - Melamine top (M)

Bureau suspendu - Plateau en mélamine (M)

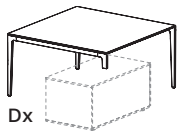

Dx  
Rh

	L. W.	P. D.	H. H.	COD.		kg lb	m <sup>3</sup> ft <sup>3</sup>
Dx Rh	140 55 <sup>1</sup> / <sub>8</sub>	140 55 <sup>1</sup> / <sub>8</sub>	75 29 <sup>1</sup> / <sub>2</sub>	<b>AL4514D</b>		52,24 115.00	0,142 5.00
Sx Lh	140 55 <sup>1</sup> / <sub>8</sub>	140 55 <sup>1</sup> / <sub>8</sub>	75 29 <sup>1</sup> / <sub>2</sub>	<b>AL4514S</b>		52,24 115.00	0,142 5.00
Dx Rh	160 63"	160 63"	75 29 <sup>1</sup> / <sub>2</sub>	<b>AL4516D</b>		62,16 137.00	0,174 6.15
Sx Lh	160 63"	160 63"	75 29 <sup>1</sup> / <sub>2</sub>	<b>AL4516S</b>		62,16 137.00	0,174 6.15

<b>Maggiorazioni</b> - Supplement - Supplement			
<b>Foratura per piano melaminico/fenix per 1 flap (non incluso)</b> Drilling melamine/fenix top for 1 top access (not included) Perçage plateau en mélamine/fenix pour 1 top access (pas inclus)	<b>APP</b>		
<b>Foratura piano melaminico/fenix per VERSATURN (non incluso)</b> Drilling for melamine/fenix top for VERSATURN (not included) Perçage plateau en mélamine/fenix pour VERSATRUN (pas inclus)	<b>APP</b>		

### APP = Posizione flap per scrivania

Top access position for desk

Position du top access pour bureau

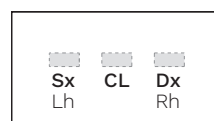

cod. **EEFL41**



metal

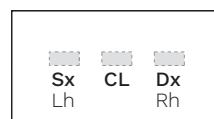

cod. **EEFM09** VERSATURN 3.0

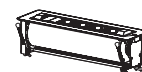

# Segrino

## Scrivania appesa - Piano in vetro verniciato lato inferiore (VTNE-VTBI-VTTR)

Hanging desk - Painted under side glass top (VTNE-VTBI-VTTR)

Bureau suspendu - Plateau en verre verni côté inférieur (VTNE-VTBI-VTTR)

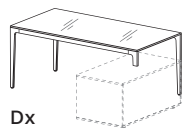

Dx  
Rh

	L. W.	P. D.	H. H.	COD.		kg lb	m <sup>3</sup> ft <sup>3</sup>
Dx Rh	180 70 <sup>7</sup> / <sub>8</sub>	90 35 <sup>3</sup> / <sub>8</sub>	75 29 <sup>1</sup> / <sub>2</sub>	<b>AL3518VD</b>		73,79 163.00	0,111 3.90
	200 78 <sup>3</sup> / <sub>4</sub>	90 35 <sup>3</sup> / <sub>8</sub>	75 29 <sup>1</sup> / <sub>2</sub>	<b>AL3520VD</b>		79,90 176.00	0,119 4.21
	220 86 <sup>5</sup> / <sub>8</sub>	90 35 <sup>3</sup> / <sub>8</sub>	75 29 <sup>1</sup> / <sub>2</sub>	<b>AL3522VD</b>		86,02 190.00	0,128 4.51
Sx Lh	180 70 <sup>7</sup> / <sub>8</sub>	90 35 <sup>3</sup> / <sub>8</sub>	75 29 <sup>1</sup> / <sub>2</sub>	<b>AL3518VS</b>		73,79 163.00	0,111 3.90
	200 78 <sup>3</sup> / <sub>4</sub>	90 35 <sup>3</sup> / <sub>8</sub>	75 29 <sup>1</sup> / <sub>2</sub>	<b>AL3520VS</b>		79,90 176.00	0,119 4.21
	220 86 <sup>5</sup> / <sub>8</sub>	90 35 <sup>3</sup> / <sub>8</sub>	75 29 <sup>1</sup> / <sub>2</sub>	<b>AL3522VS</b>		86,02 190.00	0,128 4.51

## Scrivania appesa - Piano in vetro verniciato lato inferiore (VTNE-VTBI-VTTR)

Hanging desk - Painted under side glass top (VTNE-VTBI-VTTR)

Bureau suspendu - Plateau en verre verni côté inférieur (VTNE-VTBI-VTTR)

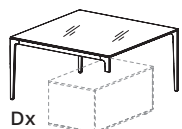

Dx  
Rh

	L. W.	P. D.	H. H.	COD.		kg lb	m <sup>3</sup> ft <sup>3</sup>
Dx Rh	140 55 <sup>1</sup> / <sub>8</sub>	140 55 <sup>1</sup> / <sub>8</sub>	75 29 <sup>1</sup> / <sub>2</sub>	<b>AL4514VD</b>		85,84 189.00	0,125 4.40
Sx Lh	140 55 <sup>1</sup> / <sub>8</sub>	140 55 <sup>1</sup> / <sub>8</sub>	75 29 <sup>1</sup> / <sub>2</sub>	<b>AL4514VS</b>		85,84 189.00	0,125 4.40
Dx Rh	160 63"	160 63"	75 29 <sup>1</sup> / <sub>2</sub>	<b>AL4516VD</b>		105,96 234.00	0,152 5.35
Sx Lh	160 63"	160 63"	75 29 <sup>1</sup> / <sub>2</sub>	<b>AL4516VS</b>		105,96 234.00	0,152 5.35

Maggiorazioni - Supplement - Supplement

Foratura per piano vetro per 1 flap (non incluso)

Drilling for glass top for 1 top access (not included)

Perçage pour plateau en verre pour 1 top access (pas inclus)

APP

Foratura piano vetro per VERSATURN (non incluso)

Drilling for glass top for VERSATURN (not included)

Perçage plateau en verre pour VERSATURN (pas inclus)

APP

## Posizione mobile di servizio

Service unit position

Position meuble de service

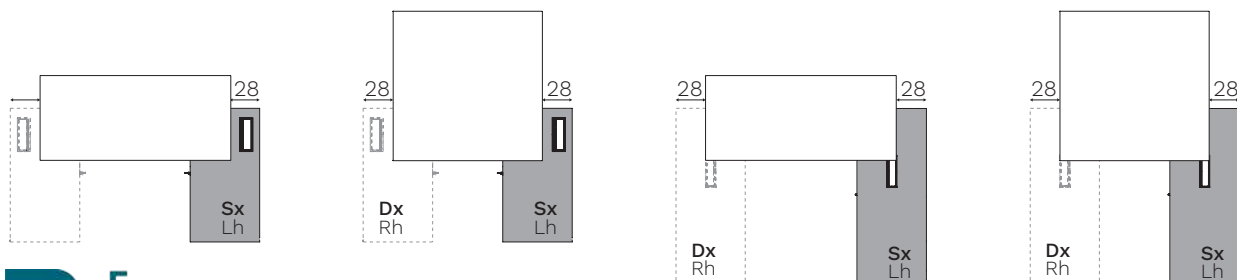

# Segrino

## Scrivania appesa - Piano in vetro acidato lato superiore, verniciato lato inferiore (VNE-VBI-VTR)

Hanging desk - Etched glass upper side, painted under side top (VNE-VBI-VTR)

Bureau suspendu - Plateau en verre dépoli en côté supérieur et verni en côté inférieur (VNE-VBI-VTR)

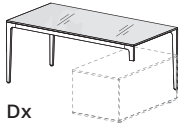

Dx  
Rh

	L. W.	P. D.	H. H.	COD.		kg lb	m <sup>3</sup> ft <sup>3</sup>
Dx Rh	180 70"7/8	90 35"3/8	75 29"1/2	<b>AL3518VD</b>		73,79 163.00	0,111 3.90
	200 78"3/4	90 35"3/8	75 29"1/2	<b>AL3520VD</b>		79,90 176.00	0,119 4.21
	220 86"5/8	90 35"3/8	75 29"1/2	<b>AL3522VD</b>		86,02 190.00	0,128 4.51
Sx Lh	180 70"7/8	90 35"3/8	75 29"1/2	<b>AL3518VS</b>		73,79 163.00	0,111 3.90
	200 78"3/4	90 35"3/8	75 29"1/2	<b>AL3520VS</b>		79,90 176.00	0,119 4.21
	220 86"5/8	90 35"3/8	75 29"1/2	<b>AL3522VS</b>		86,02 190.00	0,128 4.51

## Scrivania appesa - Piano in vetro acidato lato superiore, verniciato lato inferiore (VNE-VBI-VTR)

Hanging desk - Etched glass upper side, painted under side top (VNE-VBI-VTR)

Bureau suspendu - Plateau en verre dépoli en côté supérieur et verni en côté inférieur (VNE-VBI-VTR)

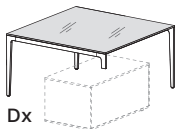

Dx  
Rh

	L. W.	P. D.	H. H.	COD.		kg lb	m <sup>3</sup> ft <sup>3</sup>
Dx Rh	140 55"1/8	140 55"1/8	75 29"1/2	<b>AL4514VD</b>		85,84 189.00	0,125 4.40
Sx Lh	140 55"1/8	140 55"1/8	75 29"1/2	<b>AL4514VS</b>		85,84 189.00	0,125 4.40
Dx Rh	160 63"	160 63"	75 29"1/2	<b>AL4516VD</b>		105,96 234.00	0,152 5.35
Sx Lh	160 63"	160 63"	75 29"1/2	<b>AL4516VS</b>		105,96 234.00	0,152 5.35

<b>Maggiorazioni - Supplement - Supplement</b>			
<b>Foratura per piano vetro per 1 flap (non incluso)</b> Drilling for glass top for 1 top access (not included) Perçage pour plateau en verre pour 1 top access (pas inclus)	<b>APP</b>		
<b>Foratura piano vetro per VERSATURN (non incluso)</b> Drilling for glass top for VERSATURN (not included) Perçage plateau en verre pour VERSATRUN (pas inclus)	<b>APP</b>		

### APP = Posizione flap per scrivania

Top access position for desk

Position du top access pour bureau

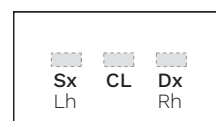

cod. **EEFL41**



metal

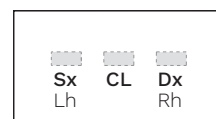

cod. **EEFM09** VERSATURN 3.0



# Segrino

## Mobile di servizio portante (A) - Maniglia in metallo (Metal) - Flap incluso

Supporting service unit (A) - Metal handle (Metal) - Top access included

Meuble de service portant (A) - Poignée en métal (Metal) - Top access inclus

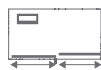
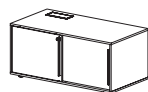

(A)

Dx

Rh



Metal

	L. W.	P. D.	H. H.	COD.		kg lb	m <sup>3</sup> ft <sup>3</sup>
Dx Rh	125 49 <sup>1</sup> / <sub>4</sub>	65 25 <sup>5</sup> / <sub>8</sub>	56 22"	<b>V954M</b>		68,68 151.00	0,185 6.53
Sx Lh	125 49 <sup>1</sup> / <sub>4</sub>	65 25 <sup>5</sup> / <sub>8</sub>	56 22"	<b>V953M</b>		68,68 151.00	0,185 6.53

## Mobile di servizio portante (B) - Maniglia in metallo (Metal) - Flap incluso

Supporting service unit (B) - Metal handle (Metal) - Top access included

Meuble de service portant (B) - Poignée en métal (Metal) - Top access inclus

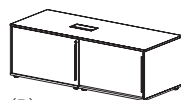

(B)

Dx

Rh



Metal

	L. W.	P. D.	H. H.	COD.		kg lb	m <sup>3</sup> ft <sup>3</sup>
Dx Rh	165 65"	65 25 <sup>5</sup> / <sub>8</sub>	56 22"	<b>PPM0962</b>		80,16 177.00	0,232 8.19
Sx Lh	165 65"	65 25 <sup>5</sup> / <sub>8</sub>	56 22"	<b>PPM0963</b>		80,16 177.00	0,232 8.19

## Cassettiera con 3 cassetti per mobile di servizio - Maniglia: ABS (PL - Plastic), metallo (Metal) - Soft-closing system - Vaschetta porta cancelleria (non inclusa)

Pedestal with 3 drawers for service unit - Handle: ABS (PL - Plastic), metal (Metal) - Soft-closing system - Stationery tray (not included)

Caisson avec 3 tiroirs pour meuble de service - Poignée: ABS (PL - Plastic), métal (Metal) - Soft-closing system - Bac à plumier (pas inclus)

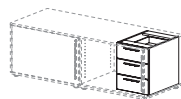

Plastic



Metal

	L. W.	P. D.	H. H.	COD.		kg lb	m <sup>3</sup> ft <sup>3</sup>
	40 15 <sup>3</sup> / <sub>4</sub>	53 20 <sup>7</sup> / <sub>8</sub>	49 19 <sup>1</sup> / <sub>4</sub>	<b>CS836</b>		16,08 35.40	0,130 4.60

## Cassettiera con 1 cassetto e 1 classificatore per mobile di servizio - Maniglia: ABS (PL - Plastic), metallo (Metal) - Soft-closing system - Vaschetta porta cancelleria (non inclusa)

Pedestal with 1 drawer and 1 filing drawer for service unit - Handle: ABS (PL - Plastic), metal (Metal) - Soft-closing system - Stationery tray (not included)

Caisson avec 1 tiroir et 1 tiroir D/S pour meuble de service - Poignée: ABS (PL - Plastic), métal (Metal) - Soft-closing system - Bac à plumier (pas inclus)

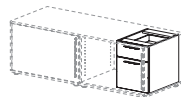

Plastic



Metal

	L. W.	P. D.	H. H.	COD.		kg lb	m <sup>3</sup> ft <sup>3</sup>
	40 15 <sup>3</sup> / <sub>4</sub>	53 20 <sup>7</sup> / <sub>8</sub>	49 19 <sup>1</sup> / <sub>4</sub>	<b>CS837</b>		19,52 43.00	0,129 4.56

## Posizione mobile di servizio

Service unit position

Position meuble de service

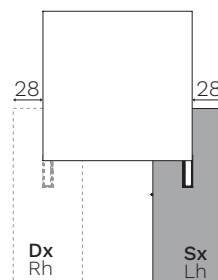
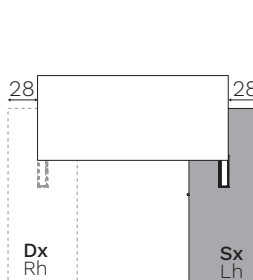
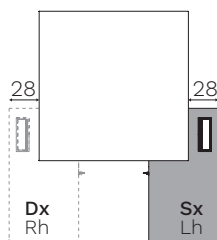
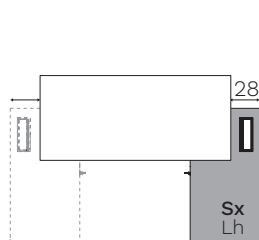

# Segrino

**Cassettiera con 2 cassetti per mobile di servizio - Maniglia: ABS (PL - Plastic), metallo (Metal) - Soft-closing system - Vaschetta porta cancelleria (non inclusa)**

Pedestal with 2 drawers for service unit - Handle: ABS (PL - Plastic), metal (Metal) - Soft-closing system - Stationery tray (not included)

Caisson avec 2 tiroirs pour meuble de service - Poignée: ABS (PL - Plastic), métal (Metal) - Soft-closing system - Bac à plumier (pas inclus)

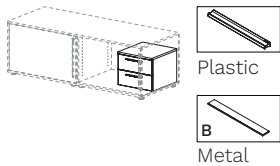

L. W.	P. D.	H. H.	COD.	kg lb	m <sup>3</sup> ft <sup>3</sup>
42 16 <sup>1</sup> / <sub>2</sub>	41 16 <sup>1</sup> / <sub>8</sub>	35 13 <sup>3</sup> / <sub>4</sub>	<b>CS835</b>	18,12 39.90	0,078 2.75

**Ripiano spostabile per mobile di servizio (A)**

Movable shelf for service unit (A)

Étagère amovible pour meuble de service (A)

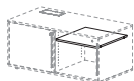

L. W.	P. D.	H. H.	COD.	kg lb	m <sup>3</sup> ft <sup>3</sup>
59,7 23 <sup>1</sup> / <sub>2</sub>	57 22 <sup>1</sup> / <sub>2</sub>	1,8 3/4"	<b>PPR059</b>	5,00 11.00	0,017 0.60

**Ripiano spostabile per mobile di servizio (B)**

Movable shelf for service unit (B)

Étagère amovible pour meuble de service (B)

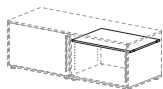

L. W.	P. D.	H. H.	COD.	kg lb	m <sup>3</sup> ft <sup>3</sup>
80 31 <sup>1</sup> / <sub>2</sub>	57 22 <sup>1</sup> / <sub>2</sub>	1,8 3/4"	<b>PPR080</b>	8,50 18.70	0,023 0.81

**Cuscino per mobile di servizio (A)**

Cushion for service unit (A)

Coussin pour meuble de service (A)

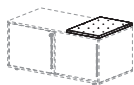

L. W.	P. D.	H. H.	COD.	kg lb	m <sup>3</sup> ft <sup>3</sup>
37 14 <sup>5</sup> / <sub>8</sub>	65 25 <sup>5</sup> / <sub>8</sub>	3 1 <sup>1</sup> / <sub>8</sub>	<b>CRC037</b>	0,90 1.98	0,013 0.46

**Cuscino per mobile di servizio (B)**

Cushion for service unit (B)

Coussin pour meuble de service (B)

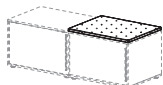

L. W.	P. D.	H. H.	COD.	kg lb	m <sup>3</sup> ft <sup>3</sup>
60 23 <sup>5</sup> / <sub>8</sub>	65 25 <sup>5</sup> / <sub>8</sub>	3 1 <sup>1</sup> / <sub>8</sub>	<b>CRC060</b>	1,24 2.73	0,021 0.74
83 32 <sup>5</sup> / <sub>8</sub>	65 25 <sup>5</sup> / <sub>8</sub>	3 1 <sup>1</sup> / <sub>8</sub>	<b>CRC083</b>	1,60 3.53	0,028 0.99

# Segrino

## Tavolo riunione - Piano: melaminico (M), Fenix (F)

Meeting table - Top: melamine (M), Fenix (F)

Table réunion - Plateau: mélamine (M), Fenix (F)

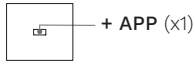



	L. W.	P. D.	H. H.	COD.		kg lb	m <sup>3</sup> ft <sup>3</sup>
	120 47 <sup>1</sup> / <sub>4</sub>	120 47 <sup>1</sup> / <sub>4</sub>	75 29 <sup>1</sup> / <sub>2</sub>	<b>AL1612</b>		44,11 97.30	0,109 3.84

## Tavolo riunione - Piano in melaminico (M)

Meeting table - Melamine top (M)

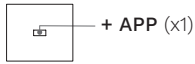
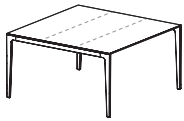
Table réunion - Plateau en mélamine (M)



	L. W.	P. D.	H. H.	COD.		kg lb	m <sup>3</sup> ft <sup>3</sup>
	140 55 <sup>1</sup> / <sub>8</sub>	140 55 <sup>1</sup> / <sub>8</sub>	75 29 <sup>1</sup> / <sub>2</sub>	<b>AL1614</b>		53,07 117.00	0,136 4.80
	160 63"	160 63"	75 29 <sup>1</sup> / <sub>2</sub>	<b>AL1616</b>		63,36 140.00	0,168 5.95

## Tavolo riunione - Piano in melaminico (M) - Muretto passaggio cavi in metallo

Meeting table - Melamine top (M) - Metal cable tower leg

Table réunion - Plateau en mélamine (M) - Pied pour passage des câbles en métal

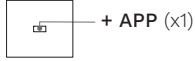
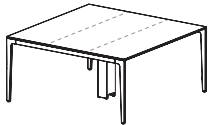



	L. W.	P. D.	H. H.	COD.		kg lb	m <sup>3</sup> ft <sup>3</sup>
	180 70 <sup>7</sup> / <sub>8</sub>	180 70 <sup>7</sup> / <sub>8</sub>	75 29 <sup>1</sup> / <sub>2</sub>	<b>AL1618</b>		82,24 181.00	0,232 8.19

## Tavolo riunione - Piano: melaminico (M), Fenix (F)

Meeting table - Top: melamine (M), Fenix (F)

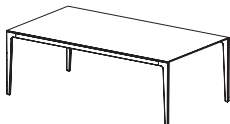
Table réunion - Plateau: mélamine (M), Fenix (F)



	L. W.	P. D.	H. H.	COD.		kg lb	m <sup>3</sup> ft <sup>3</sup>
	220 86 <sup>5</sup> / <sub>8</sub>	120 47 <sup>1</sup> / <sub>4</sub>	75 29 <sup>1</sup> / <sub>2</sub>	<b>AL1622</b>		63,66 140.00	0,175 6.19

## Maggiorazioni - Supplement - Supplement

**Foratura per piano melaminico/fenix per 1 flap (non incluso)**  
Drilling melamine/fenix top for 1 top access (not included)  
Perçage plateau en mélamine/fenix pour 1 top access (pas inclus)

**APP**

**Foratura per piano per 1 VERSATURN (non incluso)**  
Drilling for top for 1 VERSATURN (not included)  
Perçage pour plateau pour 1 VERSATURN (pas inclus)

**APP**

## APP = Posizione foro per tavolo riunione

Hole position for meeting table

Position trou pour table de réunion

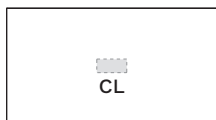

cod. **EEFL42**



metal

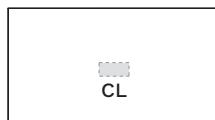

cod. **EEFM09** VERSATURN 3.0



**NOTE = Vasca di cablaggio non inclusa - Vedere schema p. 262-263**

Cable tray not included - See technical sheet on p. 262-263 - Goulotte câblage pas inclus - Voir le schéma p. 262-263

# Segrino

## Tavolo riunione - Piano: melaminico (M), Fenix (F) - Muretto passaggio cavi in metallo

Meeting table - Top: melamine (M), Fenix (F) - Metal cable tower leg

Table réunion - Plateau: mélamine (M), Fenix (F) - Pied pour passage des câbles en métal

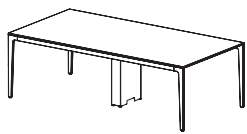

	L. W.	P. D.	H. H.	COD.		kg lb	m <sup>3</sup> ft <sup>3</sup>
8	240 94 <sup>1</sup> / <sub>2</sub>	120 47 <sup>1</sup> / <sub>4</sub>	75 29 <sup>1</sup> / <sub>2</sub>	<b>AL1624</b>		80,26 177.00	0,242 8.56



## Tavolo riunione - Piano: melaminico (M), Fenix (F) - Muretto passaggio cavi in metallo

Meeting table - Top: melamine (M), Fenix (F) - Metal cable tower leg

Table réunion - Plateau: mélamine (M), Fenix (F) - Pied pour passage des câbles en métal

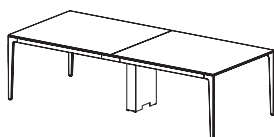

	L. W.	P. D.	H. H.	COD.		kg lb	m <sup>3</sup> ft <sup>3</sup>
10	280 110 <sup>1</sup> / <sub>4</sub>	120 47 <sup>1</sup> / <sub>4</sub>	75 29 <sup>1</sup> / <sub>2</sub>	<b>AL1628</b>		99,25 219.00	0,283 10.00
12	360 141 <sup>3</sup> / <sub>4</sub>	120 47 <sup>1</sup> / <sub>4</sub>	75 29 <sup>1</sup> / <sub>2</sub>	<b>AL1646</b>		114,51 252.00	0,336 11.90

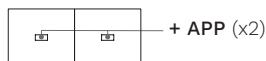

## Tavolo riunione - Piano in melaminico (M) - Muretto passaggio cavi in metallo

Meeting table - Melamine top (M) - Metal cable tower leg

Table réunion - Plateau en mélamine (M) - Pied pour passage des câbles en métal

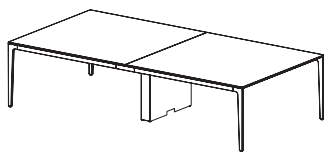

	L. W.	P. D.	H. H.	COD.		kg lb	m <sup>3</sup> ft <sup>3</sup>
10	280 110 <sup>1</sup> / <sub>4</sub>	140 55 <sup>1</sup> / <sub>8</sub>	75 29 <sup>1</sup> / <sub>2</sub>	<b>AL1638</b>		116,44 257.00	0,334 11.80
12	320 126"	160 63"	75 29 <sup>1</sup> / <sub>2</sub>	<b>AL1642</b>		134,94 297.00	0,422 14.90

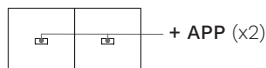

Maggiorazioni - Supplement - Supplement

**Foratura per piano melaminico/fenix per 1 flap (non incluso)**

Drilling melamine/fenix top for 1 top access (not included)  
Perçage plateau en mélamine/fenix pour 1 top access (pas inclus)

**APP**

**Foratura per piano per 1 VERSATURN (non incluso)**

Drilling for top for 1 VERSATURN (not included)  
Perçage pour plateau pour 1 VERSATURN (pas inclus)

**APP**

**APP = Posizione foro per tavolo riunione**

Hole position for meeting table

Position trou pour table de réunion

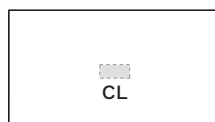
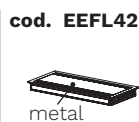
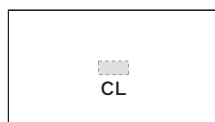

**NOTE = Vasca di cablaggio non inclusa - Vedere schema p. 263-264**

Cable tray not included - See technical sheet on p. 263-264 - Goulotte câblage pas inclus - Voir le schéma p. 263-264

# Segrino

## Tavolo riunione iniziale - Piano in melaminico (M) - Muretto passaggio cavi in metallo

Initial meeting table - Melamine top (M) - Metal cable tower leg

Table réunion initial - Plateau en mélamine (M) - Pied pour passage des câbles en métal

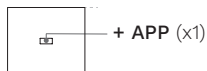
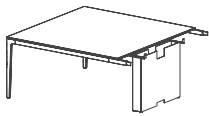

	L. W.	P. D.	H. H.	COD.		kg lb	m <sup>3</sup> ft <sup>3</sup>
6	160 63"	160 63"	75 29 <sup>1</sup> / <sub>2</sub>	<b>AL1716B</b>		78,39 173.00	0,266 9.39
6	180 70 <sup>7</sup> / <sub>8</sub>	180 70 <sup>7</sup> / <sub>8</sub>	75 29 <sup>1</sup> / <sub>2</sub>	<b>AL1718B</b>		89,32 197.00	0,303 10.70

## Tavolo riunione intermedio - Piano in melaminico (M) - Muretto passaggio cavi in metallo

Intermediate meeting table - Melamine top (M) - Metal cable tower leg

Table réunion intermédiaire - Plateau en mélamine (M) - Pied pour passage des câbles en métal

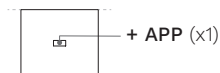
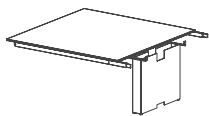

	L. W.	P. D.	H. H.	COD.		kg lb	m <sup>3</sup> ft <sup>3</sup>
4	160 63"	160 63"	75 29 <sup>1</sup> / <sub>2</sub>	<b>AL1716I</b>		72,39 160.00	0,255 9.01
4	180 70 <sup>7</sup> / <sub>8</sub>	180 70 <sup>7</sup> / <sub>8</sub>	75 29 <sup>1</sup> / <sub>2</sub>	<b>AL1718I</b>		83,32 184.00	0,293 10.30

## Tavolo riunione finale - Piano in melaminico (M)

Final meeting table - Melamine top (M)

Table réunion final - Plateau en mélamine (M)

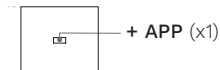
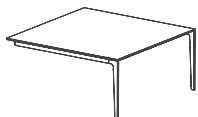

	L. W.	P. D.	H. H.	COD.		kg lb	m <sup>3</sup> ft <sup>3</sup>
6	160 63"	160 63"	75 29 <sup>1</sup> / <sub>2</sub>	<b>AL1716E</b>		58,23 128.00	0,163 5.77
6	180 70 <sup>7</sup> / <sub>8</sub>	180 70 <sup>7</sup> / <sub>8</sub>	75 29 <sup>1</sup> / <sub>2</sub>	<b>AL1718E</b>		69,16 152.00	0,201 7.10

<b>Maggiorazioni</b> - Supplement - Supplément			
<b>Foratura per piano melaminico per 1 flap (non incluso)</b> Drilling for melamine top for 1 top access (not included) Perçage pour plateau en mélamine pour 1 top access (pas inclus)	<b>APP</b>		
<b>Foratura per piano per 1 VERSATURN (non incluso)</b> Drilling for top for 1 VERSATURN (not included) Perçage pour plateau pour 1 VERSATURN (pas inclus)	<b>APP</b>		

### APP = Posizione foro per tavolo riunione

Hole position for meeting table

Position trou pour table de réunion

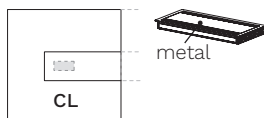

**NOTE = Vasca di cablaggio non inclusa - Vedere schema p. 264-265**

Cable tray not included - See technical sheet on p. 264-265 - Goulotte câblage pas inclus - Voir le schéma p. 264-265



# Segrino

## Tavolo riunione iniziale - Piano in melaminico (M) - Insetto centrale: melaminico (M), laccato opaco (LA), rivestito in ecopelle (Cat. D) - Muretto passaggio cavi in metallo

Initial meeting table - Melamine top (M) - Central insert: melamine (M), matt lacquered (LA), upholstered in eco-leather (Cat. D) - Metal cable tower leg

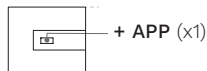
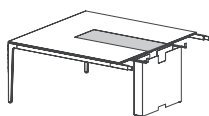
Table réunion initial - Plateau en mélamine (M) - Insert central : mélamine (M), laqué mat (LA), revêtu en simili-cuir (Cat. D) - Pied pour passage des câbles en métal



	L. W.	P. D.	H. H.	COD.	
	160 63"	160 63"	75 29 1/2"	<b>AL1816B</b>	
	180 70 7/8"	180 70 7/8"	75 29 1/2"	<b>AL1818B</b>	



	kg lb	m <sup>3</sup> ft <sup>3</sup>
	84,89 187.00	0,289 10.20
	96,32 212.00	0,329 11.60

## Tavolo riunione intermedio - Piano in melaminico (M) - Insetto centrale: melaminico (M), laccato opaco (LA), rivestito in ecopelle (Cat. D) - Muretto passaggio cavi in metallo

Intermediate meeting table - Melamine top (M) - Central insert: melamine (M), matt lacquered (LA), upholstered in eco-leather (Cat. D) - Metal cable tower leg

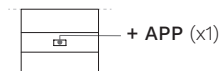
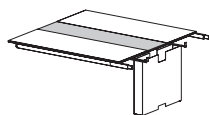
Table réunion intermédiaire - Plateau en mélamine (M) - Insert central : mélamine (M), laqué mat (LA), revêtu en simili-cuir (Cat. D) - Pied pour passage des câbles en métal



	L. W.	P. D.	H. H.	COD.	
	160 63"	160 63"	75 29 1/2"	<b>AL1816I</b>	
	180 70 7/8"	180 70 7/8"	75 29 1/2"	<b>AL1818I</b>	



	kg lb	m <sup>3</sup> ft <sup>3</sup>
	73,39 162.00	0,225 7.95
	84,42 186.00	0,253 8.92

## Tavolo riunione intermedio - Piano in melaminico (M) - Insetto centrale: melaminico (M), laccato opaco (LA), rivestito in ecopelle (Cat. D) - Muretto passaggio cavi in metallo

Intermediate meeting table - Melamine top (M) - Central insert: melamine (M), matt lacquered (LA), upholstered in eco-leather (Cat. D) - Metal cable tower leg

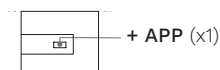
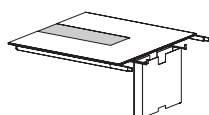
Table réunion intermédiaire - Plateau en mélamine (M) - Insert central : mélamine (M), laqué mat (LA), revêtu en simili-cuir (Cat. D) - Pied pour passage des câbles en métal



	L. W.	P. D.	H. H.	COD.	
	160 63"	160 63"	75 29 1/2"	<b>AL1826I</b>	
	180 70 7/8"	180 70 7/8"	75 29 1/2"	<b>AL1828I</b>	

	kg lb	m <sup>3</sup> ft <sup>3</sup>
	78,89 174.00	0,278 9.83
	90,32 199.00	0,318 11.20

Maggiorazioni - Supplement - Supplement

**Foratura inserto centrale per flap (non incluso)**  
Drilling for central insert for top access (not included)  
Perçage pour insert central pour top access (pas inclus)

**APP**

**Foratura inserto centrale per VERSATURN (non incluso)**  
Drilling for central insert for VERSATURN (not included)  
Perçage pour insert central pour VERSATURN (pas inclus)

**APP**

**APP = Posizione foro per tavolo riunione**

Hole position for meeting table

Position trou pour table de réunion

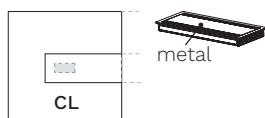

metal

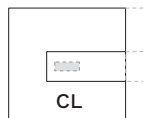

cod. **EEFM09** VERSATURN 3.0



**NOTE = Vasca di cablaggio non inclusa - Vedere schema p. 264-265**

Cable tray not included - See technical sheet on p. 264-265 - Goulotte câblage pas inclus - Voir le schéma p. 264-265

# Segrino

Tavolo riunione finale - Piano in melaminico (M) - Inserto centrale: melaminico (M), laccato opaco (LA), rivestito in ecopelle (Cat. D)

Final meeting table - Melamine top (M) - Central insert: melamine (M), matt lacquered (LA), upholstered in eco-leather (Cat. D)

Table réunion final - Plateau en mélamine (M) - Insert central : mélamine (M), laqué mat (LA), revêtu en simili-cuir (Cat. D)

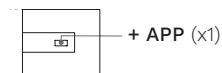
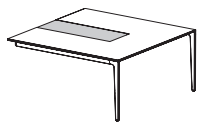

	L. W.	P. D.	H. H.	COD.		kg lb	m <sup>3</sup> ft <sup>3</sup>
 6	160 63"	160 63"	75 29 <sup>1</sup> / <sub>2</sub>	<b>AL1816E</b>		64,73 143.00	0,187 6.60
 6	180 70 <sup>7</sup> / <sub>8</sub>	180 70 <sup>7</sup> / <sub>8</sub>	75 29 <sup>1</sup> / <sub>2</sub>	<b>AL1818E</b>		76,16 168.00	0,227 8.01

Maggiorazioni - Supplement - Supplement			
<b>Foratura inserto centrale per flap (non incluso)</b> Drilling for central insert for top access (not included) Perçage pour insert central pour top access (pas inclus)	<b>APP</b>		
<b>Foratura inserto centrale per VERSATURN (non incluso)</b> Drilling for central insert for VERSATURN (not included) Perçage pour insert central pour VERSATURN (pas inclus)	<b>APP</b>		

APP = Posizione foro per tavolo riunione

Hole position for meeting table

Position trou pour table de réunion

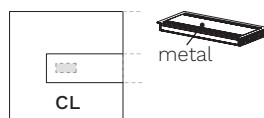

**NOTE = Vasca di cablaggio non inclusa - Vedere schema p. 264-265**

Cable tray not included - See technical sheet on p. 264-265 - Goulotte câblage pas inclus - Voir le schéma p. 264-265

# Segrino

## Tavolo riunione - Piano in vetro verniciato lato inferiore (VTNE-VTBI-VTTR)

Meeting table - Painted under side glass top (VTNE-VTBI-VTTR)

Table réunion - Plateau en verre verni côté inférieur (VTNE-VTBI-VTTR)



	L. W.	P. D.	H. H.	COD.		kg lb	m <sup>3</sup> ft <sup>3</sup>
 4	120 47"1/4	120 47"1/4	75 29"1/2	<b>AL1612V</b>		68,61 151.00	0,097 3.41

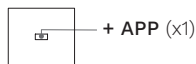

## Tavolo riunione - Piano in vetro verniciato lato inferiore (VTNE-VTBI-VTTR)

Meeting table - Painted under side glass top (VTNE-VTBI-VTTR)

Table réunion - Plateau en verre verni côté inférieur (VTNE-VTBI-VTTR)

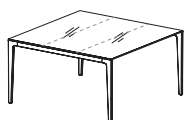

	L. W.	P. D.	H. H.	COD.		kg lb	m <sup>3</sup> ft <sup>3</sup>
 4	140 55"1/8	140 55"1/8	75 29"1/2	<b>AL1614V</b>		86,67 191.00	0,119 4.20

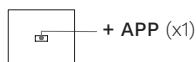

## Tavolo riunione - Piano in vetro verniciato lato inferiore (VTNE-VTBI-VTTR) - Muretto passaggio cavi in metallo

Meeting table - Painted under side glass top (VTNE-VTBI-VTTR) - Metal cable tower leg

Table réunion - Plateau en verre verni côté inférieur (VTNE-VTBI-VTTR) - Pied pour passage des câbles en métal

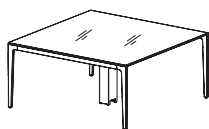

	L. W.	P. D.	H. H.	COD.		kg lb	m <sup>3</sup> ft <sup>3</sup>
 8	160 63"	160 63"	75 29"1/2	<b>AL1616V</b>		115,11 254.00	0,172 6.08

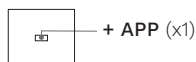

## Tavolo riunione - Piano in vetro verniciato lato inferiore (VTNE-VTBI-VTTR)

Meeting table - Painted under side glass top (VTNE-VTBI-VTTR)

Table réunion - Plateau en verre verni côté inférieur (VTNE-VTBI-VTTR)

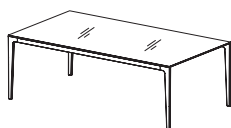

	L. W.	P. D.	H. H.	COD.		kg lb	m <sup>3</sup> ft <sup>3</sup>
 8	220 86"5/8	120 47"1/4	75 29"1/2	<b>AL1622V</b>		108,56 239.00	0,152 5.37



Maggiorazioni - Supplement - Supplement

Foratura per piano vetro per 1 flap (non incluso)

Drilling for glass top for 1 top access (not included)

Perçage pour plateau en verre pour 1 top access (pas inclus)

APP

Foratura per piano in vetro per 1 VERSATURN (non incluso)

Drilling for glass top for 1 VERSATURN (not included)

Perçage pour plateau en verre pour 1 VERSATURN (pas inclus)

APP

APP = Posizione foro per tavolo riunione

Hole position for meeting table

Position trou pour table de réunion

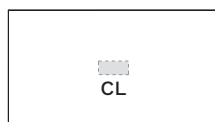

cod. EEFL42



metal

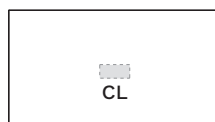

cod. EEFM09 VERSATURN 3.0



NOTE = Vasca di cablaggio non inclusa - Vedere schema p. 262-263

Cable tray not included - See technical sheet on p. 262-263 - Goulotte câblage pas inclus - Voir le schéma p. 262-263

# Segrino

## Tavolo riunione - Piano in vetro verniciato lato inferiore (VTNE-VTBI-VTTR) - Muretto passaggio cavi in metallo

Meeting table - Painted under side glass top (VTNE-VTBI-VTTR) - Metal cable tower leg

Table réunion - Plateau en verre verni côté inférieur (VTNE-VTBI-VTTR) - Pied pour passage des câbles en métal

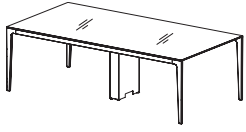



	L. W.	P. D.	H. H.	COD.		kg lb	m <sup>3</sup> ft <sup>3</sup>
 8	240 94 <sup>1</sup> / <sub>2</sub>	120 47 <sup>1</sup> / <sub>4</sub>	75 29 <sup>1</sup> / <sub>2</sub>	<b>AL1624V</b>		129,26 285.00	0,217 7.66

## Tavolo riunione - Piano in vetro verniciato lato inferiore (VTNE-VTBI-VTTR) - Muretto passaggio cavi in metallo

Meeting table - Painted under side glass top (VTNE-VTBI-VTTR) - Metal cable tower leg

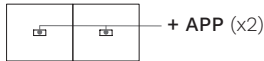
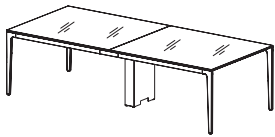
Table réunion - Plateau en verre verni côté inférieur (VTNE-VTBI-VTTR) - Pied pour passage des câbles en métal





	L. W.	P. D.	H. H.	COD.		kg lb	m <sup>3</sup> ft <sup>3</sup>
 10	240 94 <sup>1</sup> / <sub>2</sub>	120 47 <sup>1</sup> / <sub>4</sub>	75 29 <sup>1</sup> / <sub>2</sub>	<b>AL1628V</b>		156,45 345.00	0,254 8.98
 12	360 141 <sup>3</sup> / <sub>4</sub>	120 47 <sup>1</sup> / <sub>4</sub>	75 29 <sup>1</sup> / <sub>2</sub>	<b>AL1646V</b>		166,51 367.00	0,299 10.50

## Tavolo riunione - Piano in vetro verniciato lato inferiore (VTNE-VTBI-VTTR) - Muretto passaggio cavi in metallo

Meeting table - Painted under side glass top (VTNE-VTBI-VTTR) - Metal cable tower leg

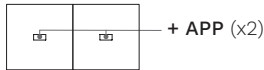
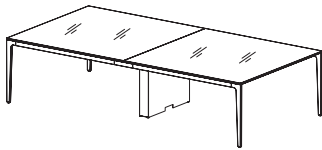
Table réunion - Plateau en verre verni côté inférieur (VTNE-VTBI-VTTR) - Pied pour passage des câbles en métal



	L. W.	P. D.	H. H.	COD.		kg lb	m <sup>3</sup> ft <sup>3</sup>
 10	240 94 <sup>1</sup> / <sub>2</sub>	140 55 <sup>1</sup> / <sub>8</sub>	75 29 <sup>1</sup> / <sub>2</sub>	<b>AL1638V</b>		183,64 405.00	0,300 10.60
 12	320 126"	160 63"	75 29 <sup>1</sup> / <sub>2</sub>	<b>AL1642V</b>		222,54 491.00	0,377 13.30

<b>Maggiorazioni - Supplement - Supplément</b>			
<b>Foratura per piano vetro per 1 flap (non incluso)</b> Drilling for glass top for 1 top access (not included) Perçage pour plateau en verre pour 1 top access (pas inclus)	<b>APP</b>		
<b>Foratura per piano in vetro per 1 VERSATURN (non incluso)</b> Drilling for glass top for 1 VERSATURN (not included) Perçage pour plateau en verre pour 1 VERSATURN (pas inclus)	<b>APP</b>		

### APP = Posizione foro per tavolo riunione

Hole position for meeting table

Position trou pour table de réunion

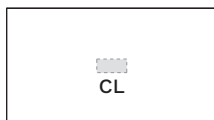

cod. EEFL42



metal

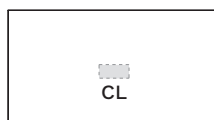

cod. EEFM09 VERSATURN 3.0



**NOTE = Vasca di cablaggio non inclusa - Vedere schema p. 263-264**

Cable tray not included - See technical sheet on p. 263-264 - Goulotte câblage pas inclus - Voir le schéma p. 263-264

# Segrino

## Tavolo riunione - Piano in vetro acidato lato superiore, verniciato lato inferiore (VNE-VBI-VTR)

Meeting table - Etched glass upper side, painted under side top (VNE-VBI-VTR)

Table réunion - Plateau en verre dépoli en côté supérieur et verni en côté inférieur (VNE-VBI-VTR)



	L. W.	P. D.	H. H.	COD.		kg lb	m <sup>3</sup> ft <sup>3</sup>
4	120 47"1/4	120 47"1/4	75 29"1/2	<b>AL1612V</b>		68,61 151.00	0,097 3.41

## Tavolo riunione - Piano in vetro acidato lato superiore, verniciato lato inferiore (VNE-VBI-VTR)

Meeting table - Etched glass upper side, painted under side top (VNE-VBI-VTR)

Table réunion - Plateau en verre dépoli en côté supérieur et verni en côté inférieur (VNE-VBI-VTR)

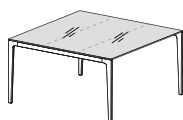

	L. W.	P. D.	H. H.	COD.		kg lb	m <sup>3</sup> ft <sup>3</sup>
4	140 55"1/8	140 55"1/8	75 29"1/2	<b>AL1614V</b>		86,67 191.00	0,119 4.20

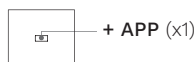

## Tavolo riunione - Piano in vetro acidato lato superiore, verniciato lato inferiore (VNE-VBI-VTR) - Muretto passaggio cavi in metallo

Meeting table - Etched glass upper side, painted under side top (VNE-VBI-VTR) - Metal cable tower leg

Table réunion - Plateau en verre dépoli en côté supérieur et verni en côté inférieur (VNE-VBI-VTR) - Pied pour passage des câbles en métal

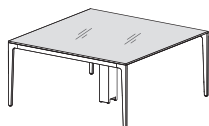

	L. W.	P. D.	H. H.	COD.		kg lb	m <sup>3</sup> ft <sup>3</sup>
8	160 63"	160 63"	75 29"1/2	<b>AL1616V</b>		115,11 254.00	0,172 6.08

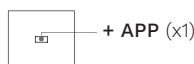

## Tavolo riunione - Piano in vetro acidato lato superiore, verniciato lato inferiore (VNE-VBI-VTR)

Meeting table - Etched glass upper side, painted under side top (VNE-VBI-VTR)

Table réunion - Plateau en verre dépoli en côté supérieur et verni en côté inférieur (VNE-VBI-VTR)

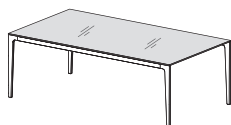

	L. W.	P. D.	H. H.	COD.		kg lb	m <sup>3</sup> ft <sup>3</sup>
8	220 86"5/8	120 47"1/4	75 29"1/2	<b>AL1622V</b>		108,56 239.00	0,152 5.37



### Maggiorazioni - Supplement - Supplement

#### Foratura per piano vetro per 1 flap (non incluso)

Drilling for glass top for 1 top access (not included)

Perçage pour plateau en verre pour 1 top access (pas inclus)

**APP**

#### Foratura per piano in vetro per 1 VERSATURN (non incluso)

Drilling for glass top for 1 VERSATURN (not included)

Perçage pour plateau en verre pour 1 VERSATURN (pas inclus)

**APP**

### APP = Posizione foro per tavolo riunione

Hole position for meeting table

Position trou pour table de réunion

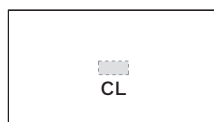

cod. EEFL42



metal

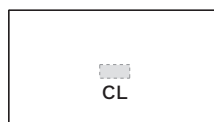

cod. EEFM09 VERSATURN 3.0



### NOTE = Vasca di cablaggio non inclusa - Vedere schema p. 262-263

Cable tray not included - See technical sheet on p. 262-263 - Goulotte câblage pas inclus - Voir le schéma p. 262-263

# Segrino

**Tavolo riunione - Piano in vetro acidato lato superiore, verniciato lato inferiore (VNE-VBI-VTR) - Muretto passaggio cavi in metallo**

Meeting table - Etched glass upper side, painted under side top (VNE-VBI-VTR) - Metal cable tower leg

Table réunion - Plateau en verre dépoli en côté supérieur et verni en côté inférieur (VNE-VBI-VTR) - Pied pour passage des câbles en métal

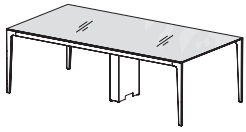

 + APP (x1)

	L. W.	P. D.	H. H.	COD.		kg lb	m <sup>3</sup> ft <sup>3</sup>
 8	240 94 <sup>1</sup> / <sub>2</sub>	120 47 <sup>1</sup> / <sub>4</sub>	75 29 <sup>1</sup> / <sub>2</sub>	<b>AL1624V</b>		129,26 285.00	0,217 7.66



**Tavolo riunione - Piano in vetro acidato lato superiore, verniciato lato inferiore (VNE-VBI-VTR) - Muretto passaggio cavi in metallo**

Meeting table - Etched glass upper side, painted under side top (VNE-VBI-VTR) - Metal cable tower leg

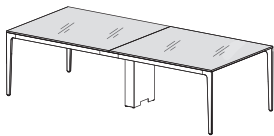
Table réunion - Plateau en verre dépoli en côté supérieur et verni en côté inférieur (VNE-VBI-VTR) - Pied pour passage des câbles en métal



 + APP (x2)

	L. W.	P. D.	H. H.	COD.		kg lb	m <sup>3</sup> ft <sup>3</sup>
 10	240 94 <sup>1</sup> / <sub>2</sub>	120 47 <sup>1</sup> / <sub>4</sub>	75 29 <sup>1</sup> / <sub>2</sub>	<b>AL1628V</b>		156,45 345.00	0,254 8.98
 12	360 141 <sup>3</sup> / <sub>4</sub>	120 47 <sup>1</sup> / <sub>4</sub>	75 29 <sup>1</sup> / <sub>2</sub>	<b>AL1646V</b>		166,51 367.00	0,299 10.50



**Tavolo riunione - Piano in vetro acidato lato superiore, verniciato lato inferiore (VNE-VBI-VTR) - Muretto passaggio cavi in metallo**

Meeting table - Etched glass upper side, painted under side top (VNE-VBI-VTR) - Metal cable tower leg

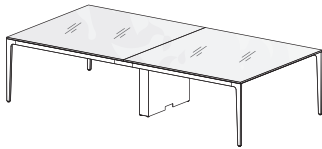
Table réunion - Plateau en verre dépoli en côté supérieur et verni en côté inférieur (VNE-VBI-VTR) - Pied pour passage des câbles en métal



 + APP (x2)

	L. W.	P. D.	H. H.	COD.		kg lb	m <sup>3</sup> ft <sup>3</sup>
 10	240 94 <sup>1</sup> / <sub>2</sub>	140 55 <sup>1</sup> / <sub>8</sub>	75 29 <sup>1</sup> / <sub>2</sub>	<b>AL1638V</b>		183,64 405.00	0,300 10.60
 12	320 126"	160 63"	75 29 <sup>1</sup> / <sub>2</sub>	<b>AL1642V</b>		222,54 491.00	0,377 13.30

<b>Maggiorazioni - Supplement - Supplément</b>			
<b>Foratura per piano vetro per 1 flap (non incluso)</b> Drilling for glass top for 1 top access (not included) Perçage pour plateau en verre pour 1 top access (pas inclus)	<b>APP</b>		
<b>Foratura per piano in vetro per 1 VERSATURN (non incluso)</b> Drilling for glass top for 1 VERSATURN (not included) Perçage pour plateau en verre pour 1 VERSATURN (pas inclus)	<b>APP</b>		

**APP = Posizione foro per tavolo riunione**

Hole position for meeting table

Position trou pour table de réunion

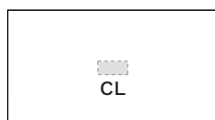

cod. **EEFL42**



metal

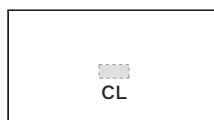

cod. **EEFM09** VERSATURN 3.0



**NOTE = Vasca di cablaggio non inclusa - Vedere schema p. 263-264**

Cable tray not included - See technical sheet on p. 263-264 - Goulotte câblage pas inclus - Voir le schéma p. 263-264

# Segrino

## Strutture per contenitori

Structure for cabinets

Structure pour meubles

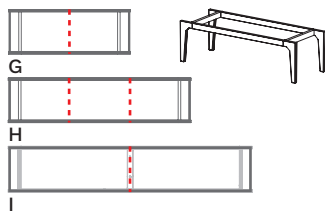

	L. W.	P. D.	H. H.	COD.		kg lb	m <sup>3</sup> ft <sup>3</sup>
G	120 47 <sup>1</sup> / <sub>4</sub>	44 17 <sup>3</sup> / <sub>8</sub>	37 14 <sup>5</sup> / <sub>8</sub>	<b>ALF21204</b>		11,95 26.40	0,015 0.53
H	180 70 <sup>7</sup> / <sub>8</sub>	44 17 <sup>3</sup> / <sub>8</sub>	37 14 <sup>5</sup> / <sub>8</sub>	<b>ALF31804</b>		14,32 31.60	0,018 0.63
I	240 94 <sup>1</sup> / <sub>2</sub>	44 17 <sup>3</sup> / <sub>8</sub>	37 14 <sup>5</sup> / <sub>8</sub>	<b>ALF42404</b>		19,50 43.00	0,029 1.02

## Contenitore a giorno H. 38 cm

H. 15<sup>1</sup>/<sub>8</sub> open unit cabinet

Meuble à jour Ht. 38 cm

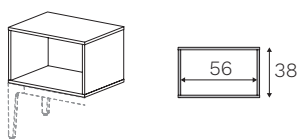

	L. W.	P. D.	H. H.	COD.		kg lb	m <sup>3</sup> ft <sup>3</sup>
	60 23 <sup>5</sup> / <sub>8</sub>	44 17 <sup>3</sup> / <sub>8</sub>	38 15 <sup>1</sup> / <sub>8</sub>	<b>ALC5111</b>		14,30 31.50	0,124 4.38

## Contenitore a giorno H. 77 cm

H. 30<sup>1</sup>/<sub>4</sub> open unit cabinet

Meuble à jour Ht. 77 cm

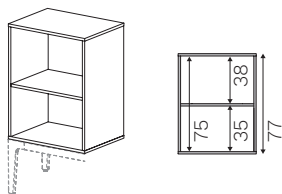

	L. W.	P. D.	H. H.	COD.		kg lb	m <sup>3</sup> ft <sup>3</sup>
	60 23 <sup>5</sup> / <sub>8</sub>	44 17 <sup>3</sup> / <sub>8</sub>	77 30 <sup>3</sup> / <sub>8</sub>	<b>ALC5121</b>		25,04 55.20	0,228 8.05

## Contenitore H. 38 cm ad 1 anta e vano a giorno - Apertura push-pull

H. 15<sup>1</sup>/<sub>8</sub> cabinet with 1-door and open unit - Push-pull opening

Meuble Ht. 38 cm avec 1 porte et niche à jour - Ouverture push-pull

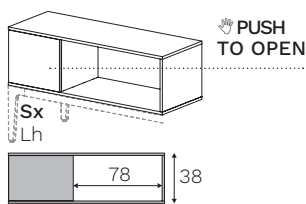

	L. W.	P. D.	H. H.	COD.		kg lb	m <sup>3</sup> ft <sup>3</sup>
Sx Lh	120 47 <sup>1</sup> / <sub>4</sub>	44 17 <sup>3</sup> / <sub>8</sub>	38 15 <sup>1</sup> / <sub>8</sub>	<b>ALC5315</b>		28,73 63.30	0,240 8.48
Dx Rh	120 47 <sup>1</sup> / <sub>4</sub>	44 17 <sup>3</sup> / <sub>8</sub>	38 15 <sup>1</sup> / <sub>8</sub>	<b>ALC5415</b>		28,73 63.30	0,240 8.48

## Contenitore H. 77 cm ad 1 anta e vano a giorno - Apertura push-pull

H. 30<sup>1</sup>/<sub>4</sub> cabinet with 1 door and open unit - Push-pull opening

Meuble Ht. 77 cm avec 1 porte et niche à jour - Ouverture push-pull

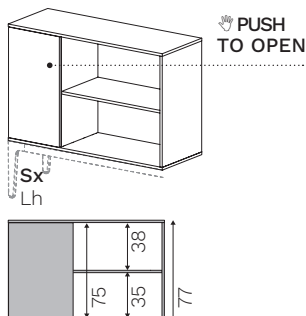

	L. W.	P. D.	H. H.	COD.		kg lb	m <sup>3</sup> ft <sup>3</sup>
Sx Lh	120 47 <sup>1</sup> / <sub>4</sub>	44 17 <sup>3</sup> / <sub>8</sub>	77 30 <sup>3</sup> / <sub>8</sub>	<b>ALC5325</b>		49,98 110.00	0,468 16.50
Dx Rh	120 47 <sup>1</sup> / <sub>4</sub>	44 17 <sup>3</sup> / <sub>8</sub>	77 30 <sup>3</sup> / <sub>8</sub>	<b>ALC5425</b>		49,98 110.00	0,468 16.50

# Segrino

## Gonna H. 30 cm con staffe

H. 11<sup>3</sup>/<sub>4</sub> modesty panel with supports

Voile de fond Ht. 30 cm avec équerres

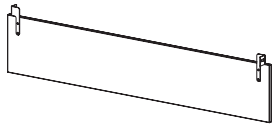

	L. W.	P. D.	H. H.	COD.		kg lb	m <sup>3</sup> ft <sup>3</sup>
<b>140</b> 55 <sup>1</sup> / <sub>8</sub>	120 47 <sup>1</sup> / <sub>4</sub>	1,8 3/4"	30 11 <sup>3</sup> / <sub>4</sub> "	<b>AL0314S</b>		6,06 13.30	0,021 0.76
<b>160</b> 63"	140 55 <sup>1</sup> / <sub>8</sub>	1,8 3/4"	30 11 <sup>3</sup> / <sub>4</sub> "	<b>AL0316S</b>		6,86 15.10	0,025 0.87
<b>180</b> 70 <sup>7</sup> / <sub>8</sub>	160 63"	1,8 3/4"	30 11 <sup>3</sup> / <sub>4</sub> "	<b>AL0318S</b>		7,66 16.90	0,028 0.99
<b>200</b> 78 <sup>3</sup> / <sub>4</sub>	180 70 <sup>7</sup> / <sub>8</sub>	1,8 3/4"	30 11 <sup>3</sup> / <sub>4</sub> "	<b>AL0320S</b>		8,36 18.40	0,031 1.11
<b>220</b> 86 <sup>5</sup> / <sub>8</sub>	200 78 <sup>3</sup> / <sub>4</sub>	1,8 3/4"	30 11 <sup>3</sup> / <sub>4</sub> "	<b>AL0322S</b>		9,51 21.00	0,036 1.26

## Gonna H. 56 cm con staffe

H. 22" modesty panel with supports

Voile de fond Ht. 56 cm avec équerres

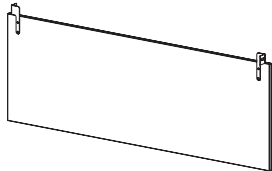

	L. W.	P. D.	H. H.	COD.		kg lb	m <sup>3</sup> ft <sup>3</sup>
<b>140</b> 55 <sup>1</sup> / <sub>8</sub>	120 47 <sup>1</sup> / <sub>4</sub>	1,8 3/4"	56 22"	<b>AL0314H</b>		10,16 22.40	0,038 1.34
<b>160</b> 63"	140 55 <sup>1</sup> / <sub>8</sub>	1,8 3/4"	56 22"	<b>AL0316H</b>		11,66 25.70	0,044 1.55
<b>180</b> 70 <sup>7</sup> / <sub>8</sub>	160 63"	1,8 3/4"	56 22"	<b>AL0318H</b>		13,06 28.80	0,050 1.77
<b>200</b> 78 <sup>3</sup> / <sub>4</sub>	180 70 <sup>7</sup> / <sub>8</sub>	1,8 3/4"	56 22"	<b>AL0320H</b>		14,56 32.10	0,056 1.98
<b>220</b> 86 <sup>5</sup> / <sub>8</sub>	200 78 <sup>3</sup> / <sub>4</sub>	1,8 3/4"	56 22"	<b>AL0322H</b>		16,41 36.20	0,063 2.23

# Segrino

## Vasca cablaggio per scrivania - Da fissare al telaio

Desk cable tray - To be fixed to the frame

Goulotte câblage pour bureau - À fixer au châssis



	L. W.	P. D.	H. H.	COD.		kg lb	m <sup>3</sup> ft <sup>3</sup>
<b>140</b> 55"1/8	120 47"1/4	14,5 5"3/4	9 3"1/2	<b>AL9214</b>		3,80 8.38	0,042 1.47
<b>160</b> 63"	140 55"1/8	14,5 5"3/4	9 3"1/2	<b>AL9216</b>		4,30 9.48	0,048 1.70
<b>180</b> 70"7/8	160 63"	14,5 5"3/4	9 3"1/2	<b>AL9218</b>		4,70 10.40	0,054 1.91
<b>200</b> 78"3/4	180 70"7/8	14,5 5"3/4	9 3"1/2	<b>AL9220</b>		5,20 11.50	0,061 2.16
<b>220</b> 86"5/8	200 78"3/4	14,5 5"3/4	9 3"1/2	<b>AL9222</b>		5,70 12.60	0,068 2.39

## Vasca cablaggio regolabile in altezza (H. 12,5 ÷ 15,4 cm) per bench

Height-adjustable cable tray (H. 4"7/8 ÷ 6"1/8) for bench desk

Goulotte câblage réglable en hauteur (Ht. 12,5 ÷ 15,4 cm) pour bureau double

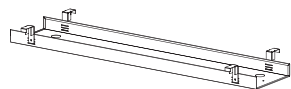

	L. W.	P. D.	H. H.	COD.		kg lb	m <sup>3</sup> ft <sup>3</sup>
<b>140</b> 55"1/8	120 47"1/4	34 13"3/8	7 2"3/4	<b>PP9214</b>		5,50 12.10	0,034 1.18
<b>160</b> 63"	140 55"1/8	34 13"3/8	7 2"3/4	<b>PP9216</b>		6,30 13.90	0,039 1.37
<b>180</b> 70"7/8	160 63"	34 13"3/8	7 2"3/4	<b>PP9218</b>		7,10 15.70	0,044 1.56

## Coppia tappi di chiusura per vasca cablaggio bench

Pair of closing caps for bench desk cable tray

2 bouchons de fermeture pour goulotte câblage pour bureau double



L. W.	P. D.	H. H.	COD.		kg lb	m <sup>3</sup> ft <sup>3</sup>
34 13"3/8	1,3 1/2"	7 2"3/4	<b>PP9209</b>		0,60 1.32	0,001 0.04

## Vertebra passacavi in metallo

Metal vertical cable duct

Passer-câbles vertical en métal

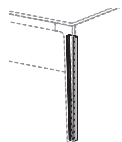

**AL9237**

L. W.	P. D.	H. H.	COD.		kg lb	m <sup>3</sup> ft <sup>3</sup>
6 2"3/8	3 1"1/8	64 25"1/4	<b>AL9237</b>		0,90 1.98	0,002 0.07

## Vertebra passacavi in tessuto - Chiusura a zip

Fabric vertical cable duct - Zip closure

Passer-câbles vertical en tissu - Fermeture à glissière

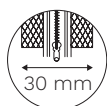
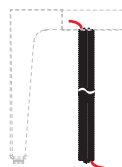

L. W.	P. D.	H. H.	COD.		kg lb	m <sup>3</sup> ft <sup>3</sup>
3 1"1/8	3 1"1/8	75 29"1/2	<b>CS9204</b>		0,10 0.22	0,001 0.04

# Segrino

## Vasca cablaggio per tavoli riunione - Da fissare al telaio

Cable tray for meeting table - To be fixed to the frame

Goulotte câblage pour table réunion - À fixer au châssis



	L. W.	P. D.	H. H.	COD.		kg lb	m <sup>3</sup> ft <sup>3</sup>
<b>120</b> 47"1/4	100 39"3/8	14,5 5"3/4	9 3"1/2	<b>AL9212</b>		3,40 7.50	0,035 1.25
<b>140</b> 55"1/8	120 47"1/4	14,5 5"3/4	9 3"1/2	<b>AL9214</b>		3,80 8.38	0,042 1.47
<b>160</b> 63"	140 55"1/8	14,5 5"3/4	9 3"1/2	<b>AL9216</b>		4,30 9.48	0,048 1.70
<b>180</b> 70"7/8	160 63"	14,5 5"3/4	9 3"1/2	<b>AL9218</b>		4,70 10.40	0,054 1.91
<b>220</b> 86"5/8	200 78"3/4	14,5 5"3/4	9 3"1/2	<b>AL9222</b>		5,70 12.60	0,068 2.39

## Vasca cablaggio per tavoli riunione in composizione - Da fissare al telaio

Cable tray for meeting table in compositions - To be fixed to the frame

Goulotte câblage pour table réunion en composition - À fixer au châssis



	L. W.	P. D.	H. H.	COD.		kg lb	m <sup>3</sup> ft <sup>3</sup>
<b>140</b> 55"1/8	100 39"3/8	14,5 5"3/4	9 3"1/2	<b>AL9210</b>		3,40 7.50	0,035 1.25
<b>160</b> 63"	110 43"1/4	14,5 5"3/4	9 3"1/2	<b>AL9211</b>		3,60 7.94	0,039 1.36
<b>140</b> 55"1/8	120 47"1/4	14,5 5"3/4	9 3"1/2	<b>AL9214</b>		3,80 8.38	0,042 1.47
<b>160</b> 63"	140 55"1/8	14,5 5"3/4	9 3"1/2	<b>AL9216</b>		4,30 9.48	0,048 1.70
<b>180</b> 70"7/8	160 63"	14,5 5"3/4	9 3"1/2	<b>AL9218</b>		4,70 10.40	0,054 1.91

## Muretto passaggio cavi in metallo per tavolo riunione Cod. AL1612-14-16-18

Metal cable tower leg for meeting tables Cod. AL1612-14-16-18

Pied pour passage des câbles en métal pour table réunion Cod. AL1612-14-16-18



L. W.	P. D.	H. H.	COD.		kg lb	m <sup>3</sup> ft <sup>3</sup>
12,5 4"7/8	16,4 6"1/2	68 26"3/4	<b>AL9251</b>		7,95 17.50	0,026 0.93

## Muretto passaggio cavi in metallo per tavolo riunione Cod. AL1622-24

Metal cable tower leg for meeting table Cod. AL1622-24

Pied pour passage des câbles en métal pour table réunion Cod. AL1622-24

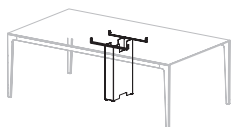

L. W.	P. D.	H. H.	COD.		kg lb	m <sup>3</sup> ft <sup>3</sup>
12,5 4"7/8	40 15"3/4	68 26"3/4	<b>AL9252</b>		12,78 28.20	0,054 1.91

# Segrino

VERSADOT - 1 x POWER - Staffa per aggancio a struttura inclusa - Cavo di alimentazione non incluso

VERSADOT - 1 x POWER - Bracket for attachment to structure included - Power cable not included

VERSADOT - 1 x POWER - Support pour fixation à la structure inclus - Câble d'alimentation pas inclus

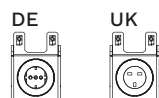
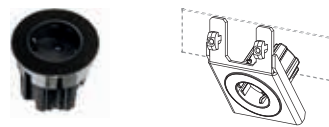

	L. W.	P. D.	H. H.	COD.		kg lb	m <sup>3</sup> ft <sup>3</sup>
DE	6 2 <sup>3</sup> / <sub>8</sub>	6 2 <sup>3</sup> / <sub>8</sub>	5,8 2 <sup>1</sup> / <sub>4</sub>	<b>EEFM18A02</b>		0,66 1.46	0,003 0.11
UK	6 2 <sup>3</sup> / <sub>8</sub>	6 2 <sup>3</sup> / <sub>8</sub>	5,8 2 <sup>1</sup> / <sub>4</sub>	<b>EEFM18A03</b>		0,66 1.46	0,003 0.11

VERSADOT - 1 x USB "Type A" 5V - 1 x USB "Type C" 5V - Staffa per aggancio a struttura inclusa - Cavo di alimentazione non incluso

VERSADOT - 1 x USB "Type A" 5V - 1 x USB "Type C" 5V - Bracket for attachment to structure included - Power cable not included

VERSADOT - 1 x USB "Type A" 5V - 1 x USB "Type C" 5V - Support pour fixation à la structure inclus - Câble d'alimentation pas inclus

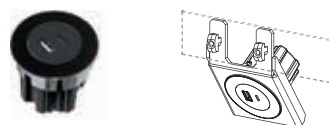

	L. W.	P. D.	H. H.	COD.		kg lb	m <sup>3</sup> ft <sup>3</sup>
	6 2 <sup>3</sup> / <sub>8</sub>	6 2 <sup>3</sup> / <sub>8</sub>	5,8 2 <sup>1</sup> / <sub>4</sub>	<b>EEFM18A05</b>		0,66 1.46	0,003 0.11

Cavo di alimentazione L. 200 cm con spina (DE-UK) e connettore GST-18 femmina a 3 poli

W. 78\*3/4 power cable with plug (DE-UK) and GST-18 female 3 pole connector

Câble d'alimentation L. 200 cm avec fiche (DE-UK) et connecteur GST-18 3 pôles femelle

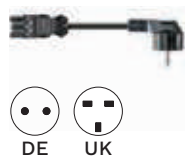

	L. W.	COD.		kg lb	m <sup>3</sup> ft <sup>3</sup>
DE	200 78*3/4	<b>EECB01</b>		0,28 0.62	0,002 0.06
UK	200 78*3/4	<b>EECB03</b>		0,70 1.54	0,009 0.33